



Stormwater Management

THE INFILTRATION RANGE



INFILTRATION MODULES INFILTRATION FILTERS
RETENTION CISTERNS SHAFTS AND ACCESSORIES



Production site in Dachstein (France)



Production site in Teningen (Germany) near Freiburg



GRAF – Setting standards in quality

For 50 years, Otto Graf GmbH has been offering high-class plastic products to its customers. In 1974, GRAF developed its first pioneering range of rainwater harvesting products. Today we are market leader in numerous countries for Rainwater Harvesting Systems.

High Quality Manufacturing

Graf is investing continuously in the expansion of the headquarters in Teningen near Freiburg (Breisgau). The facility has now an approximate area of 155.000 m² and is one of the most modern production facilities for plastic products in the world.

Our choice of Germany for the new production site was easy. On the one hand, we feel an obligation to the site because of our history. On the other, we would like to offer our customers products of the highest quality.

Quality is at the forefront

To ensure consistent high product quality, you need optimised production processes and outstanding quality management. Every individual tank at the new production site in Teningen is checked for dimensional accuracy, wall thickness and weight.

All production parameters, e.g. material composition, machine settings and the staff involved in the production process, are documented for each individual product.

Our goal: your satisfaction

More than 100,000 satisfied customers already benefit from the advantages of GRAF rainwater harvesting systems.



Manufacturing certified according to ISO 9001

High Quality Manufacturing

Our products have to satisfy a huge number of different requirements, which is why GRAF is an expert in all the common procedures for manufacturing plastic products and has access to the optimum manufacturing process for every product.

Ecological products from the technology leader

GRAF uses state-of-the-art production facilities. This is the only way to guarantee superlative quality at attractive prices. GRAF broke new ground by using injection embossing to make the Carat underground tank. To manufacture this tank, the company developed and constructed the world's largest injection moulding machine.

Durable and 100 % recyclable

Right from the stage of developing its products, GRAF attaches great importance to sustainable product design.

Long product lives ensure that fewer resources are used and the environmental impact is minimised. All products manufactured by GRAF are 100 % recyclable.

Some products are also made from recycled materials – yet another boost to the environmental credentials of the GRAF product range. This means that not only do GRAF products protect the environment during use but their manufacturing process is also ecologically sound.

Sustainable production processes

While GRAF products help protect the environment, they are also manufac-

tured in an environmentally-sound way. For example, the injection moulding process consumes up to **85% less energy** than normal.

The heat generated during manufacturing is processed by a modern heat recovery system and is used to heat the production and logistics building.



Manufacturing certified according to ISO 50001



World's biggest injection moulding machine



Blow moulding process



Rotational moulding

	Basic information	Preserving the natural cycle Dimensioning and planning of infiltration systems Loads and angles of friction	9 10 12
	EcoBloc system	System overview The system at a glance Vario 800 flex shaft Accessories Technical data Application examples	18 20 24 27 28 30
	Infiltration Tunnel/ Infiltration Tunnel twin	System overview The system at a glance Technical data Application examples	38 40 43 44
	Infiltration and Multi shaft system	Infiltration and Multi shaft system Shaft system DN 400 (16") Shaft system DN 600 (24")	49 50 51
	Filter technology	Universal filter 3 external, Universal industrial filter 3 external Infiltration filter shaft, settling filter shaft	52 53
	KLsepa.compact	Light fluid separator	54
	Water detention and retention systems	Detention/Retention overview Detention Carat S Retention Carat S Detention Platin Retention Platin Detention/Retention Carat XL Detention/Retention Carat XXL Detention/Infiltration Herkules	57 58 59 60 61 62 64 66

Advice, planning and products from one source

What we offer:

- Dimensioning according to DWA-A 138 and DWA-M 153 for infiltration systems
- Sizing for infiltration / retention systems
- Overflow verification according to DIN1986-100
- Assistance with drainage planning proposal
- Assistance with and evaluation of soil survey

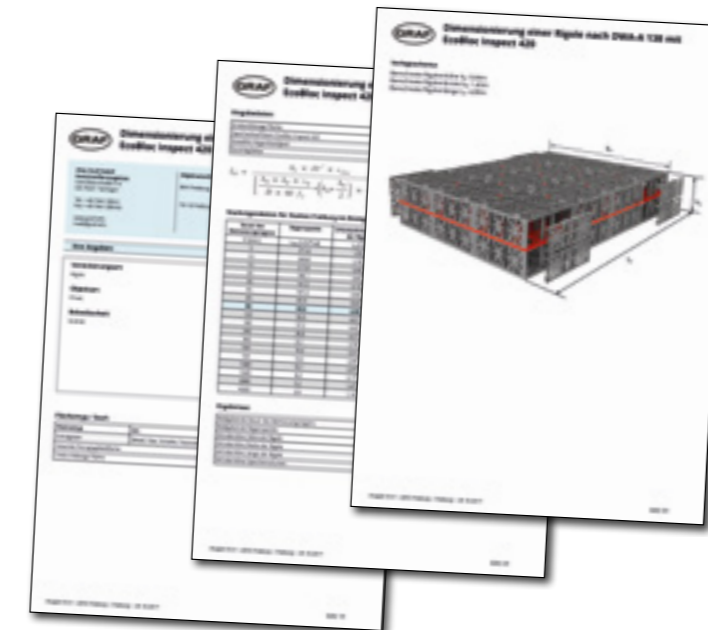

On-site support:

If you are planning an infiltration system and need on-site assistance or one-to-one advice from our technical team, then

we can help. We work with you to develop customised systems to clean, store, infiltrate, attenuate or harvest rainwater.

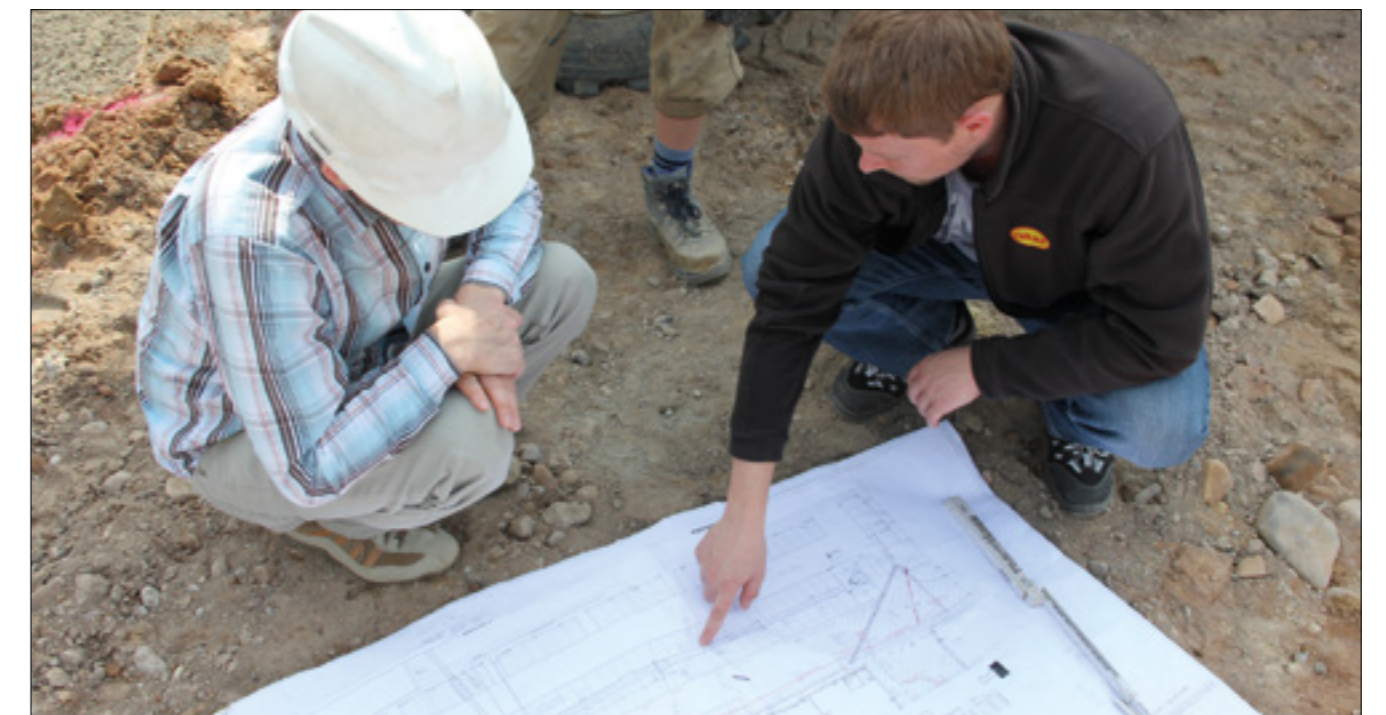

Webcode G4107

The webcode will lead you directly to the required information.

- Installation instructions
- Technical drawings
- Detailed product information
- Downloads

www.graf-water.com

Symbols in the catalogue

Load capacity

- Suitable for pedestrian loading
- Suitable for vehicle loading
- Lorry-bearing

Internationally proven: GRAF infiltration technology



Stormwater management ▶ References



Business Park, Hradec Králové (CZ)



Car dealership, Sofia (BG)



Energy supplier, Warwick (UK)



Industrial building, Tumeltsham (AT)



DIY chain store, Bratislava (SK)



Recycling centre, Vresová (CZ)

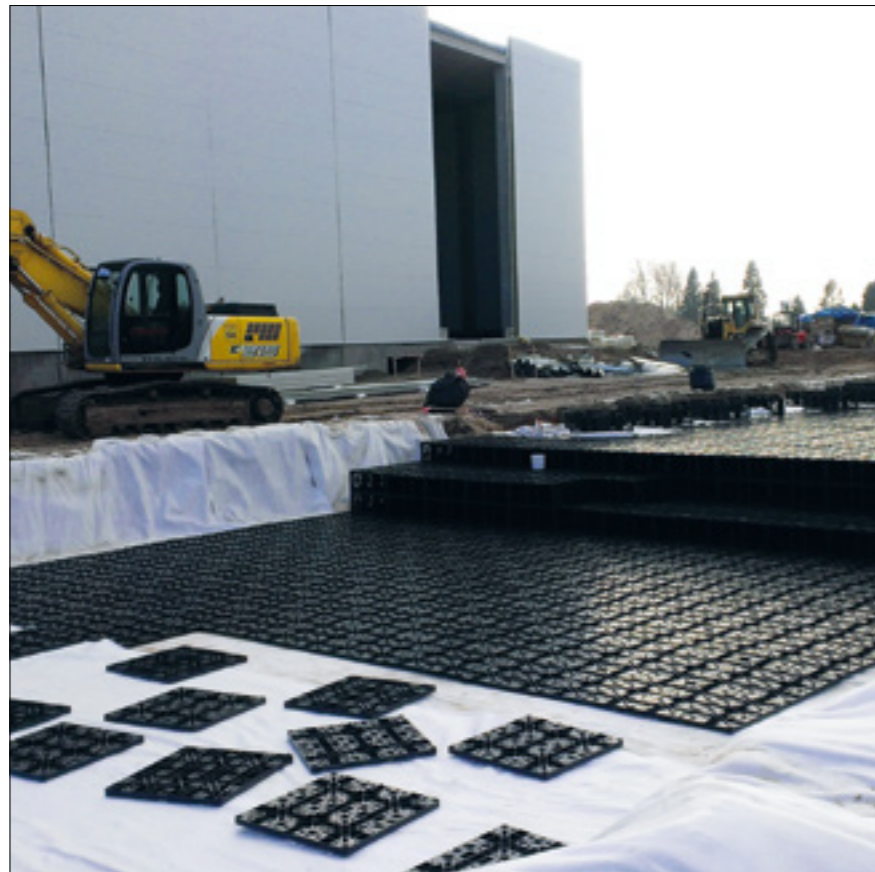

Shopping center, Kent (UK)



Military building, Mazuren (PL)



Industrial building, Merseburg (DE)



Football stadium, Le Havre (FR)

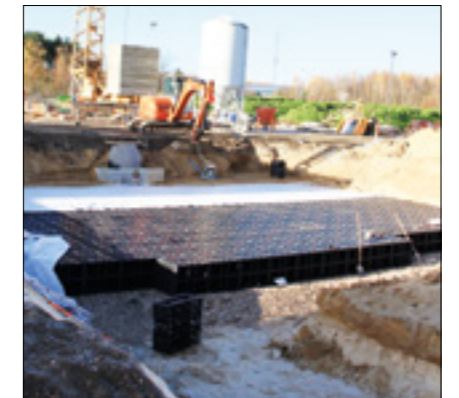

Production site, Ludwigsfelde (DE)



City park, Barcelona (ES)

Stormwater management ▶ References

Internationally proven: GRAF infiltration technology



DIY chain store, Århus (DK)



Housing development, Singapur (SG)



Housing development, Buenos Aires (AR)



Industrial warehouse, Raben (PL)



Warehouse, Prag (CZ)



Restaurant, Stockholm (SE)

Preserving the natural cycle



Surface sealing **disrupts** groundwater recharge



Decentralised infiltration **promotes** groundwater recharge

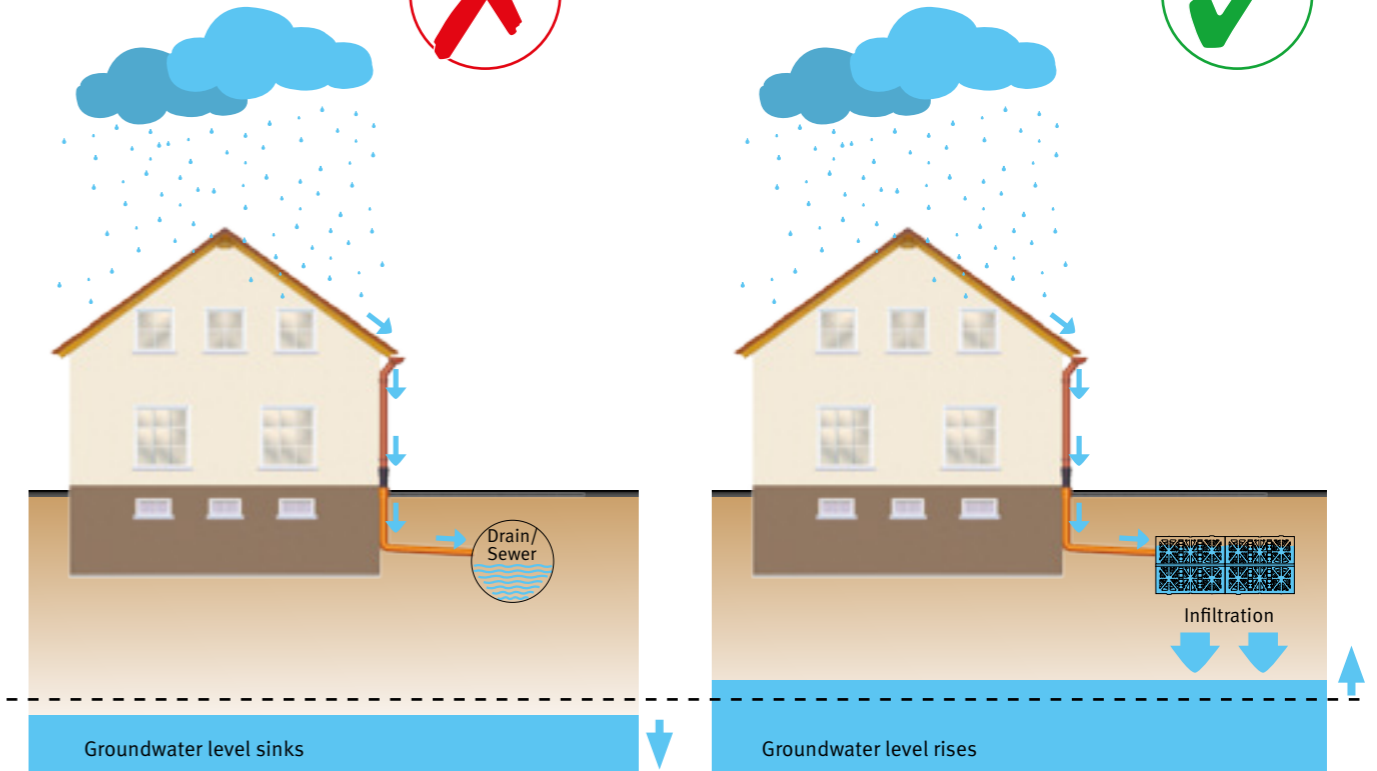

Legal change

With the adoption of the European Water Framework Directive (2000/60/EC), the European Parliament and of the council has set the goal of using water more sustainably and in a more environmentally friendly way. The European states will be responsible for implementing this directive.

The Water Resources Acts of most European countries will therefore be amended. The implementations can be found in many current versions – among others:

"rainwater should be drained away and irrigated locally ..., as long as this is not opposed by water legislation, other provisions of public law or water management issues."

The infiltration of rainwater locally offers considerable advantages over the previously customary draining into combined wastewater/separate sewage systems:

- Promotes groundwater recharge
- Reduces costs through lower structural costs – sewers in the separate network and wastewater lifting units can be dimensioned on a smaller scale
- Reduces the effects of surface sealing
- Minimises the hydraulic loads in the sewer system during storms
- Contributes to flooding prevention



Dimensioning and planning of infiltration systems

The following parameters are required to evaluate an infiltration system:

- ✓ **Determination of the catchment areas**
Connected roofs, road spaces or other sealed surfaces are evaluated with regard to the actual outflow.
- ✓ **Examination of the ground**
Determination of the permeability of the ground (k_f value in m/s). This value plays a decisive role and a miscalculation can have far-reaching consequences.
- ✓ **Return period**
An infiltration or retention system is designed as a function of heavy rainfall events that are likely to occur over a given period of time. This period of time may vary from 5 to 100 years due to local government laws and regulations. Most of the calculations are done with 5 year rain data.

Determination of the catchment areas

The collected rainwater can be fed into ditches and drained away from roof surfaces, parking areas, paving and other sealed surfaces. Evaporation and the partially direct infiltration through the collection surfaces result in a reduction of the amount of rain that ends up in the infiltration system. This leads to differing outflow coefficients for the connected surface types (see table below). The projected surfaces are relevant for the evaluation of the amount of rain and may deviate substantially from the roof surface, particularly in the case of sloping roofs.

The effectively impermeable surface for ditch evaluation can be evaluated using the outflow coefficient and the catchment area.

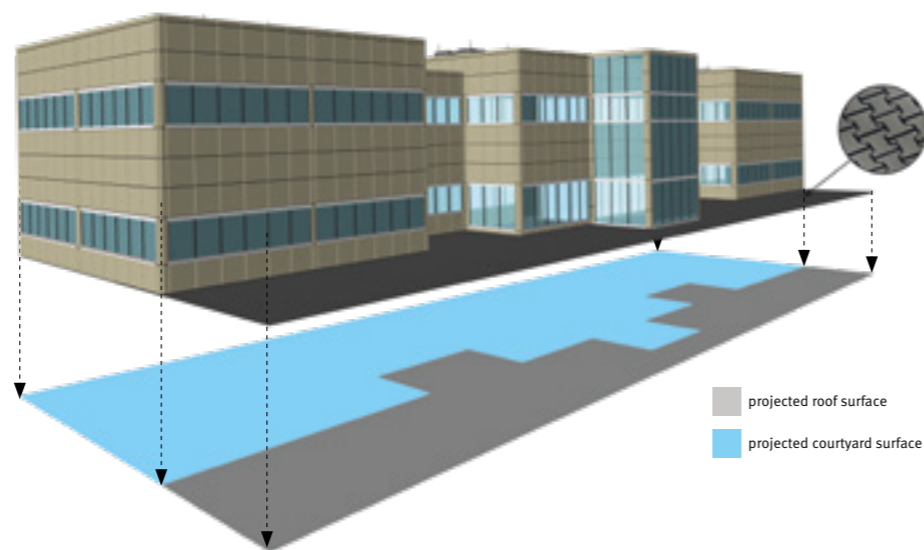

Type of surface

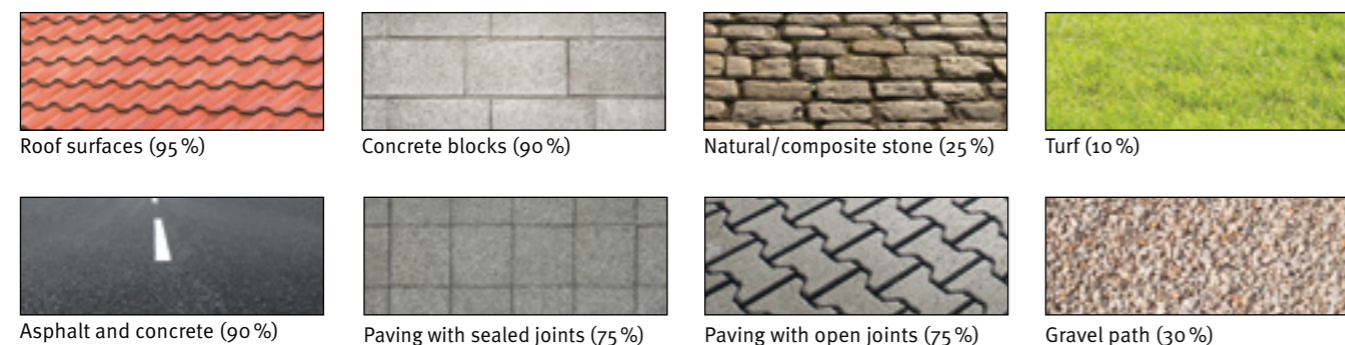

Examination of the ground

The ground conditions and the layer structure play an essential role in the planning of an infiltration system. The permeability of the ground and the ground/stratum water define the size and location of the ditch. A soil report should at the least include window sampling or trenching near the installation location for the evaluation of the infiltration performance. In addition, informa-

tion or evaluations for the construction of an infiltration system can be found in most soil reports. The result of the window sampling or trenching is a layer model which depicts the ground types and their distribution and thickness down to the digging depth. Infiltration systems must not be installed in layers, with permeability of $< 1 \times 10^{-6}$ m/s (clay or cohesive soil with high clay capac-

ity). However, the ground may display a maximum permeability of $\leq 1 \times 10^{-3}$ m/s, since a minimum retention period should be achieved in the soil layers before entry of groundwater.

If the ground properties do not permit infiltration, the required k_f values can be achieved using soil replacement in special cases.

Recommended permeability values:

Soil type

Soil type	Permeability values
Coarse gravel	medium to strong
Fine gravel	medium to strong
Gravel/sand mix	medium to strong
Medium sand	medium to strong
Fine sand	medium to strong
Sand with a loam capacity	medium to strong
Silt (loam)	medium to strong
Loam with a clay capacity	weak to medium
Clay	weak
Permeability values	weak, medium, strong

Suitable soil for infiltration

Return period

The size of an infiltration or detention system depends on heavy rainfall events which occur over a given period of time. This period of time may vary from 5 to 100 years due to local government laws and regulations. Most of the calculations are done with 5 year rain data, see picture/table below.

Values given as an example:

D [min]	rain flow [l/s*ha]	rain volume [l/100 m ²]
5	380.7	1142.1
10	245.6	1473.6
20	158.9	1906.8
30	123.4	2221.2
60	80.3	2890.8
120	47.8	3441.6
240	28.4	4089.6
540	15.5	5022
720	12.5	5400
1440	7.3	6307.2
2880	4.1	7084.8
4320	2.9	7516.8

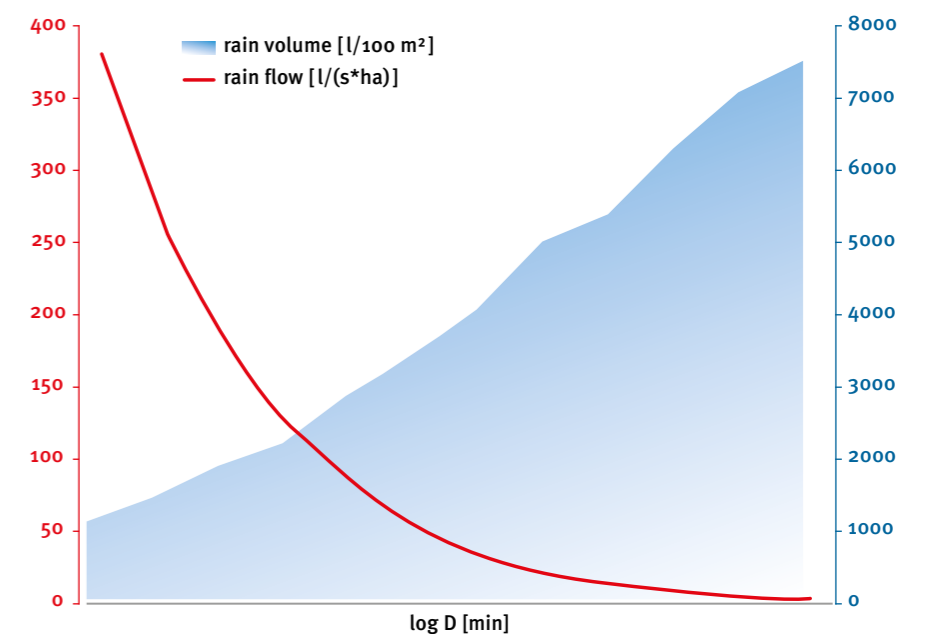

In combination with soil type, the critical value (max. value for infiltration system dimensions) could lie between 5 minutes (good soil) and 4320 minutes (clay or loam).

Loads and angles of friction

The installation depths and maximum fill cover heights are very much dependent on the loading of the finished surface and the type of system material used. When a vehicle makes contact with the surface, its weight is first converted into a point load. The asphalt structure and the soil layers beneath it distribute this load according to their mechanical properties. For the soil layers, the angle of friction ϕ' (see page 13)

is decisive. To achieve even loading of the infiltration system elements, a suitable minimum soil cover is required. The infiltration system elements are also subject to horizontal loading, resulting from the vertical loading being diverted by the internal rigidity of the filler material in the soil. The horizontal loading limits the maximum depth at which the infiltration system elements can be installed.

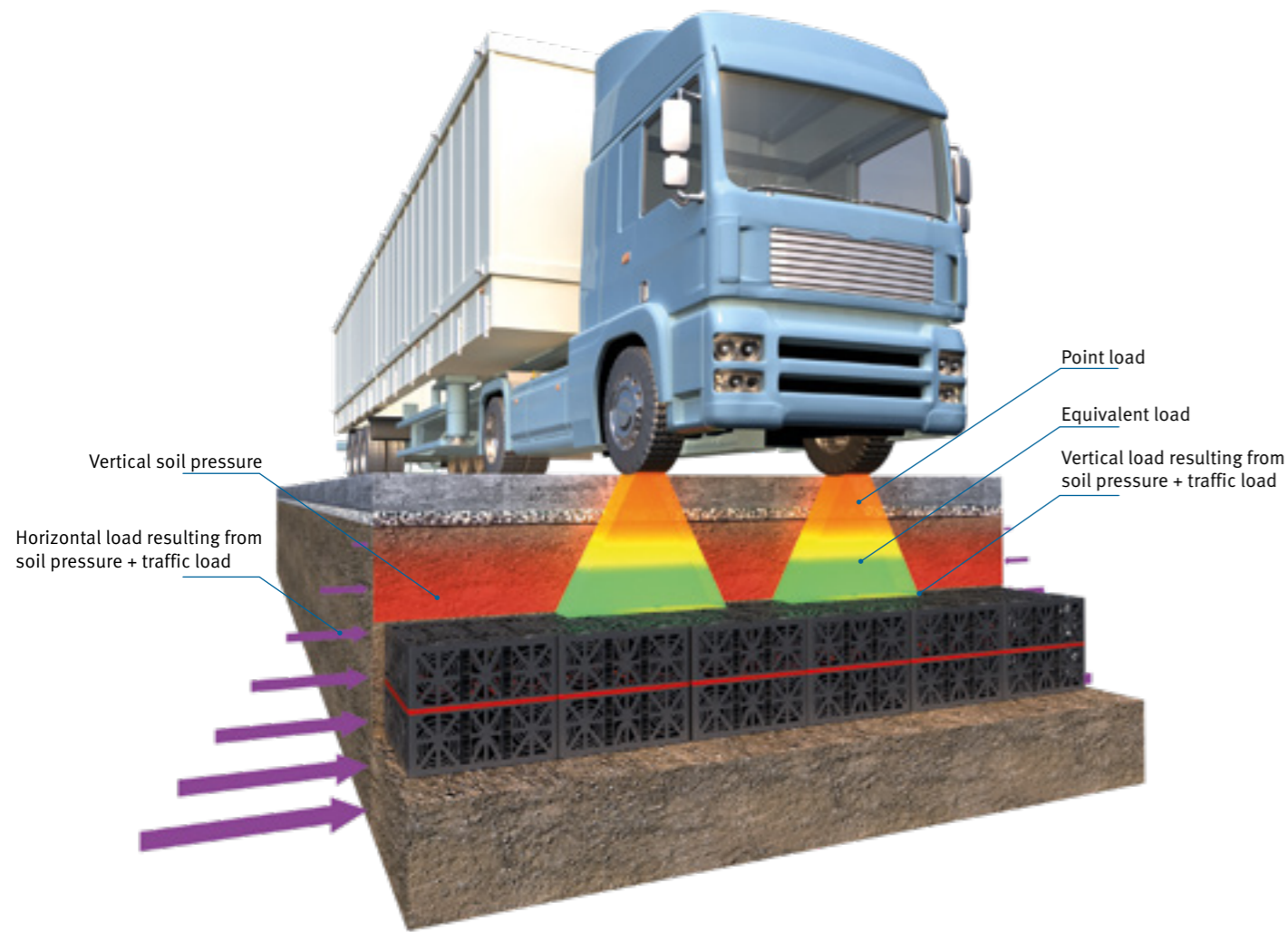

Traffic loads

Point load

The infiltration system elements can be installed in areas of pedestrian loading (without vehicle traffic) and areas with calmed vehicle traffic up to a maximum total weight of 60 tons. This includes car parks and access roads with low speeds. In areas of pedestrian loading, traffic load is normally assumed to be 0 kN/m^2 . In areas with traffic loading, a distinction must be made between point loads and distributed loads. Point loads decrease exponentially as depth increases, partly related to the angle of friction. The fill material reduces the point load and causes the traffic load to be evenly distributed.

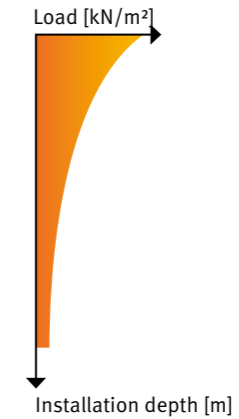

Equivalent load

National standards also require the equivalent load for road surfaces to be taken into account. In theory, the equivalent load is an evenly distributed load (e.g. national standards in Germany use Lorry 60 t $\cong 33.3 \text{ kN/m}^2$ equivalent load, British standards use 10 kN/m^2 w/o safety factors for high loading distributed loads) based on the total weight of the vehicle in relation to the projected contact area. For a theoretical load calculation the equivalent load is not dependent on the installation depth and therefore remains constant.

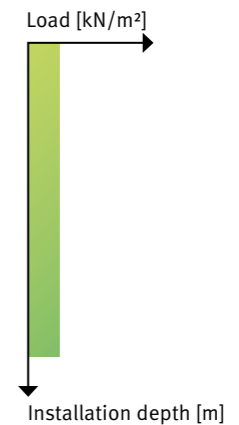

Result: traffic load

To assess traffic load, the maximum point load or equivalent load must always be used for design purposes.

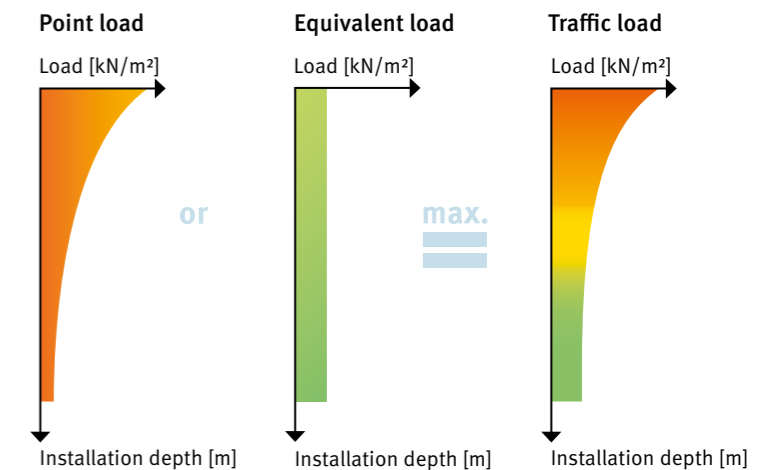

Loads and angles of friction

continued

Vertical soil pressure

The covering soil layers / soil fill cover produce vertical soil pressure. This is linear and depends on the installation depth / height of the fill cover and the density of the chosen material. The vertical soil pressure is normally estimated to be around 20 kN/m² per metre of fill cover.



Vertical loads

The vertical load comprises the traffic load and soil pressure as described above. The sum of the two loads is therefore dependent on the installation depth. This limits the maximum permitted fill cover on top of the infiltration elements.

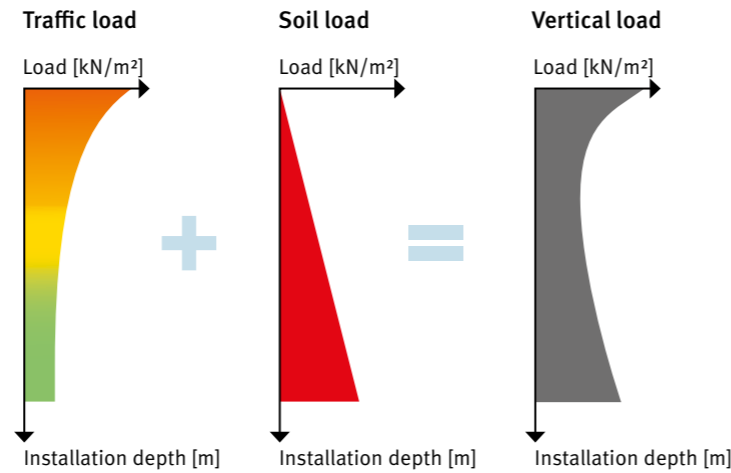

Vertical loads – overall evaluation

The approved long-term vertical load for the EcoBloc Inspect with a lifetime of 50 years is 59 kN/m² including safety factor of 2.0. Some national standards and certificates like BBA in UK use different calculation methods, see BBA certificates for GRAF products. Both the approved vertical loads and the vertical loads actually present limit the installation window of the ditch elements with the minimum and maximum installation depth. The installation window for the infiltration tunnel / twin infiltration tunnel can be calculated in the same way.

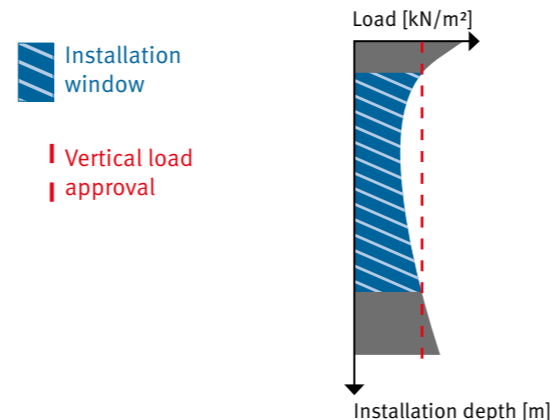

Horizontal load

The angle of friction has an important influence on the horizontal loading. Part of this vertical load is converted into a horizontal load by the internal rigidity of the filler material.

The horizontal load is also dependent on the height of the fill cover, i.e. the installation depth, and limits the installation window for the infiltration ditch elements.

Class	Suitable for pedestrian loading	Car	Lorry 12	Lorry 30	Lorry 40	Lorry 60
Installation depth (max.) [m] $\phi' = 20^\circ$	3.00	3.00	3.00	2.75	2.50	2.25
Installation depth (max.) [m] $\phi' = 30^\circ$	4.25	4.25	4.25	3.75	3.75	3.25
Installation depth (max.) [m] $\phi' = 40^\circ$	5.00	5.00	5.00	5.00	5.00	5.00

If infiltration system elements are to be installed for the storage of rainwater (retention or rainwater harvesting), additional loads caused by the presence / rising of groundwater must be evaluated.

Angle of friction

The fill material used has a significant influence on the horizontal load and therefore the load which the system element must withstand at the sides. The angle of friction ϕ' describes the effective angle of internal friction of a material. The effect of the angle of friction can be seen, for example, in a heap of a granular medium (e.g. sand or gravel). The greater the angle

of friction ϕ' , the higher such a medium can be piled up. In addition, the greater the angle of friction and thus the internal rigidity of the material, the lower the horizontal load. A high angle of friction also favours the distribution of the point load into an evenly distributed load. Preference should therefore always be given to a filler material with a high angle of friction.

Material	Loam	Loam/sand mix	Sand	Gravel
Angle of friction ϕ'	15° – 25°	25° – 30°	30° – 35°	35° – 40°



EcoBloc storm

EcoBloc stormwater management system

Various applications

- ✓ Rainwater infiltration
- ✓ Stormwater attenuation
- ✓ Rainwater harvesting



Fully integrated shaft

The Vario 800 flex shaft system (page 26) can be directly installed in an EcoBloc infiltration or infiltration/attenuation system. The connection surfaces of the inspection channels in the Vario 800 flex shaft system are accurately matched to the EcoBloc system.

Lorry-bearing up to 60 tons

The EcoBloc Inspect flex has a heavy-duty lorry-bearing capacity of 60 tons with an 800 mm (2' 7.5") earth covering.

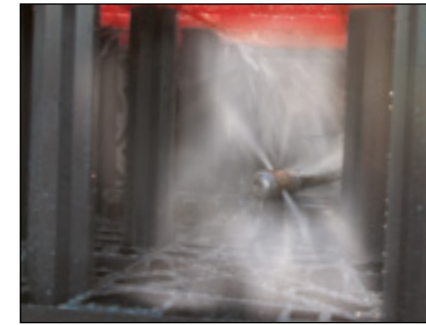

High pressure jetting possible

EcoBloc Inspect flex can easily resist high pressure jetting.

Easy to inspect

The standard inspection channel allows the entire infiltration/attenuation system to be monitored effectively. The EcoBloc Inspect flex allows access by commercially available inspection cameras. This has been confirmed by several independent testing authorities.

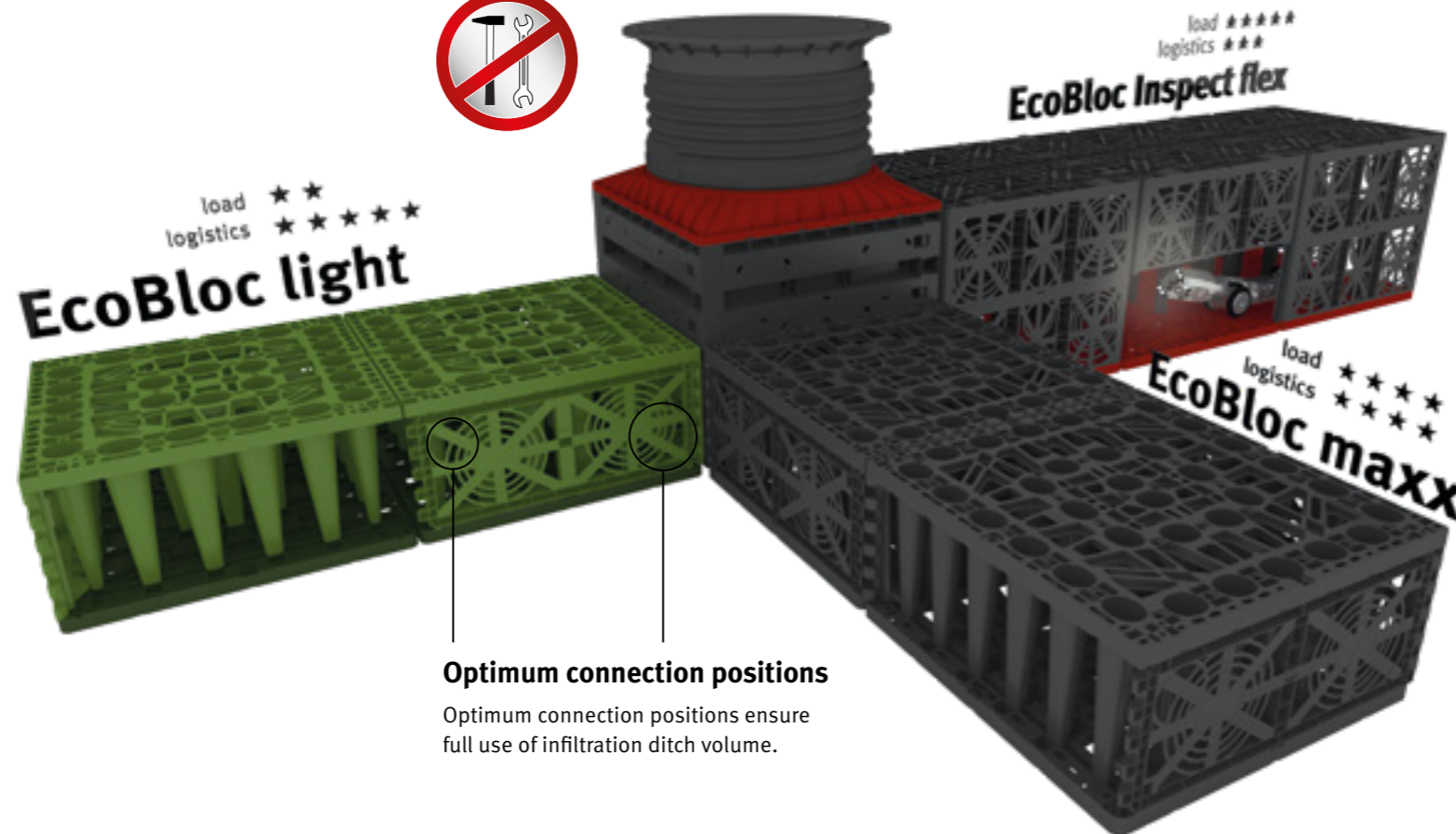

Optimum connection positions
Optimum connection positions ensure full use of infiltration ditch volume.



High storage volume

GRAF infiltration modules have three times the storage volume of a standard gravel infiltration ditch. Two modules therefore take the place of around 1300 kg (1,4 tons) of gravel or a 50 m (164') drainage pipe. Since you don't have to excavate so much soil and enjoy great value for money compared with a standard gravel infiltration ditch, the GRAF modules save you hard-earned cash!



Service life of over 50 years

A durable product design ensures sustainability. The EcoBloc system and the Vario 800 flex shaft system is designed for a service life of over 50 years.

Easy to install

The modules are fitted simply, at speed and in various ways. They can be installed without heavy machinery – one EcoBloc Inspect flex module weighs just 8 kg (17.6 lbs), even only 7 kg (15.4 lbs) for one EcoBloc light

Up to 97% reservoir volume

The EcoBloc light has a gross volume of 225 litres (59.4 US gal.) and a reservoir volume of 219 litres (57.9 US gal.). With a reservoir volume in excess up to 97%, it is a market-leading product. The EcoBloc variants maxx and Inspect flex still offer a reservoir coefficient of 96% despite their high load-bearing capacity.

Installation depth of up to 5 metres (16' 4.8")

Even under very heavy loads, GRAF EcoBloc Inspect flex modules can be installed at a depth of up to 5 metres (16' 4.8"). This means that up to 14 layers are possible. Please consult GRAF when the installation depth is greater than 5 metres.

GRAF EcoBloc Configurator

Please ask your GRAF sales consultant for your login account information to the GRAF EcoBloc Configurator.



The EcoBloc system at a glance

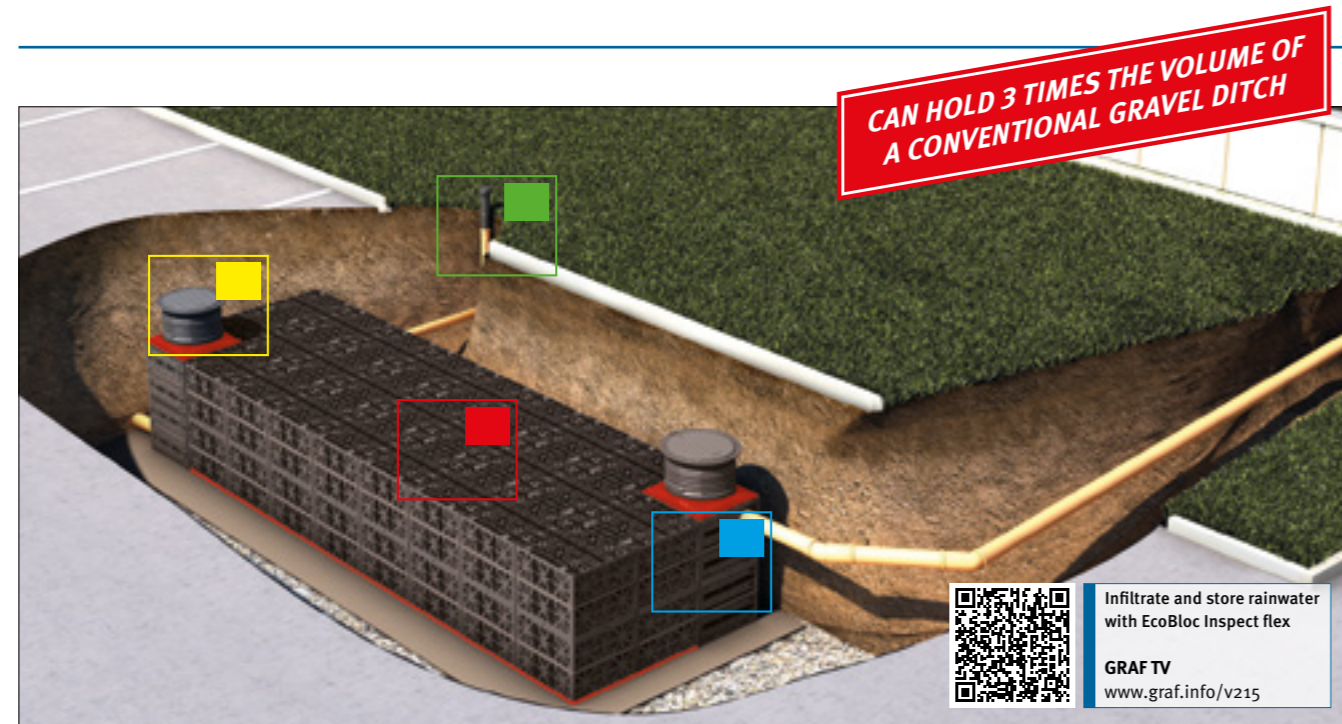

Application and logistics

Eco-friendly product – green logistics

One lorry can transport up to 2700 EcoBloc light modules. That corresponds to a volume of 610 m³ (161,145 US gal.). This reduces carbon emissions during transport by 85%!

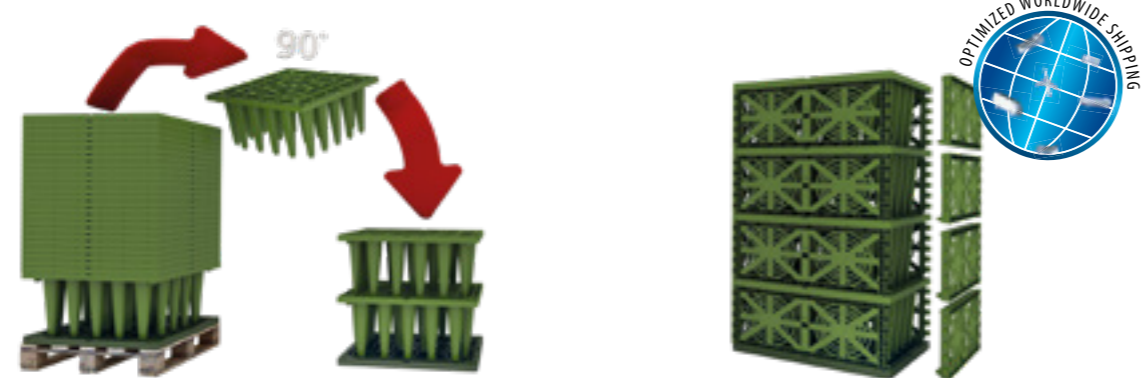

1. Stackable











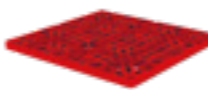



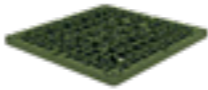





To save space during transport, the EcoBloc maxx and EcoBloc light modules are stacked into each other. This minimizes transport costs, storage space in stock and CO₂ emissions.

2. Easy installation

The EcoBloc base plate forms the foundations of each EcoBloc system. Up to 13 EcoBloc modules can be fitted on one base plate.

3. Ready

The side faces are sealed with EcoBloc end plates. The EcoBloc system can be adapted to match individual requirements.

Infiltration system body	Infiltration system body accessories	Shaft	Shaft accessories
EcoBloc Inspect flex Page 22  EcoBloc Inspect flex base plate Page 22  EcoBloc maxx Page 22  EcoBloc maxx base plate Page 22  EcoBloc light Page 23  EcoBloc light base plate Page 23 	Deaeration end, geotextile, and connectors Page 23  EcoBloc Inspect flex end plates Page 22  EcoBloc maxx end plates Page 22  EcoBloc light end plates Page 23  EcoBloc adaptor plate Page 23 	Vario 800 flex, type 1 Page 26  Vario 800 flex, type 2 Page 26  Vario 800 flex, base/cover set Page 26 	Telescopic dome shaft pedestrian loading Page 27  Telescopic dome shaft vehicle loading max. load 3.5 t Page 27  Telescopic dome shaft lorry bearing Page 27  Infiltration inlet module DN 600 (24") Page 27  Infiltration connecting piece 1000 DN 600 (24") Page 27  Infiltration filter strainer DN 600 (24") Page 27  Choke drain pack 1 DN 100 (4"), pack 2 DN 150 (6"), pack 3 floating choke drains Page 27 

EcoBloc system

Modules



EcoBloc Inspect flex

- Lorry-bearing 60 tons/HS-25
- 150 m³ (39,600 US gal.)/Truck
- Inspectable
- High pressure jetting possible

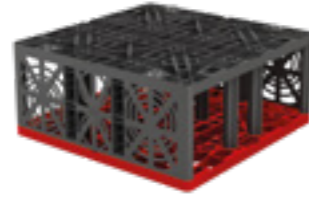

Load ★★★★★
Logistics ★★★



EcoBloc Inspect flex

DN 100 (4") / 150 (6") / 200 (8") connecting surfaces

Volume	Length	Width	Height	Weight	Colour	Order no.
205 l (54.2 US gal.)	800 mm (2' 7.5")	800 mm (2' 7.5")	320 mm (12.6")	8 kg (17.6 lbs)	grey	402005

Webcode G4107

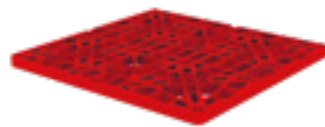

EcoBloc Inspect flex base plate

Forms the foundation of the EcoBloc Inspect flex system

Volume	Length	Width	Height	Weight	Colour	Order no.
25 l (6.6 US gal.)	800 mm (2' 7.5")	800 mm (2' 7.5")	40 mm (1.6")	4 kg (8.8 lbs)	grey	402006

EcoBloc Inspect flex end plates

The front ends of an EcoBloc Inspect flex system are sealed by end plates with DN 100 (4") / 150 (6") / 200 (8") contact surfaces



Item	Colour	Order no.
EcoBloc Inspect flex end plates (Set 2 units)	grey	402002

EcoBloc maxx

- Lorry-bearing 40 tons/HS-20
- 410 m³ (108,310 US gal.)/Truck

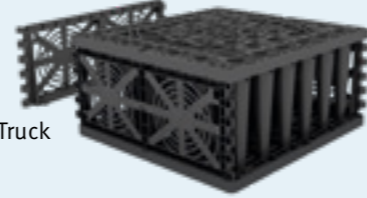

Load ★★★★★
Logistics ★★★★★

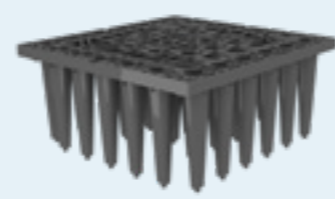

EcoBloc maxx

Connecting surfaces on EcoBloc maxx end plates

Volume	Length	Width	Height	Weight	Colour	Order no.
225 l (59.4 US gal.)	800 mm (2' 7.5")	800 mm (2' 7.5")	350 mm (13.8")	9 kg (19.8 lbs)	black	402200

Webcode G4108



EcoBloc maxx base plate

Forms the foundation of the EcoBloc maxx system

Volume	Length	Width	Height	Weight	Colour	Order no.
25 l (6.6 US gal.)	800 mm (2' 7.5")	800 mm (2' 7.5")	40 mm (1.6")	4 kg (8.8 lbs)	black	402201

EcoBloc maxx end plates

The outside surface of an EcoBloc maxx system is sealed by end plates with contact surfaces DN 100 (4") / 150 (6") / 200 (8") / 250 (10")

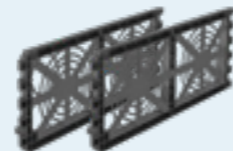

Item	Colour	Order no.
EcoBloc maxx end plates (Set 2 units)	black	402203

EcoBloc light

- Lorry-bearing 12 tons
- 610 m³ (161,145 US gal.)/Truck

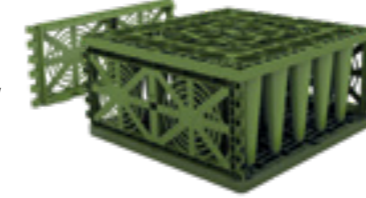

Load ★★
Logistics ★★★★★

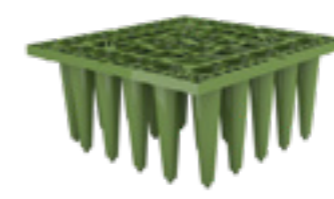

EcoBloc light

Connecting surfaces on EcoBloc light end plates

Volume	Length	Width	Height	Weight	Colour	Order no.
225 l (59.4 US gal.)	800 mm (2' 7.5")	800 mm (2' 7.5")	350 mm (13.8")	7 kg (15.4 lbs)	green	402300

Webcode G4109

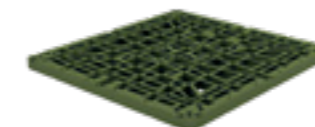

EcoBloc light base plate

Forms the foundation of the EcoBloc light system

Volume	Length	Width	Height	Weight	Colour	Order no.
25 l (6.6 US gal.)	800 mm (2' 7.5")	800 mm (2' 7.5")	40 mm (1.6")	4 kg (8.8 lbs)	green	402301

EcoBloc light end plates

The outside surface of an EcoBloc light system is sealed by end plates with contact surfaces DN 100 (4") / 150 (6") / 200 (8") / 250 (10")

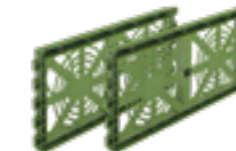

Item	Colour	Order no.
EcoBloc light end plates (Set 2 units)	green	402303

EcoBloc System accessories

EcoBloc connectors

For horizontal connection

Order no. 402015	Set 10 units
Order no. 402018	Set 25 units
Order no. 402020	Set 50 units
Order no. 402025	Set 200 units



Deaeration end

DN 100 (4")

Order no. 369017



EcoBloc adaptor plate

DN 300 (12") / DN 400 (16") / DN 500 (20")

Order no. 402033



GRAF-Tex geotextile

size of 2.50 x 2.50 m (8' 2.4" x 8' 2.4")

Order no. 231006



Sold by the metre, roll width 5 m (16' 4.8")

Order no. 231002

Sold by the metre, roll width 2,5 m (8' 2.4")

Order no. 231007

EcoBloc system

Vario 800 flex shaft



Flexible use

The Vario 800 shaft provides easy access to all EcoBloc modules. It can be used in many different ways:

- ✓ As an inspection shaft
- ✓ As an inlet shaft
- ✓ As a filter shaft
- ✓ As a flow control shaft

Easy to inspect

The Vario 800 shaft allows easy access to the EcoBloc system by commercially available inspection cameras. This has been confirmed by several independent testing authorities.

Lorry-bearing up to 60 tons

The GRAF Vario 800 shaft has a heavy-duty lorry-bearing capacity of 60 tons with an 800 mm (2' 7.5") earth covering. The fibreglass reinforced material gives the shaft extra strength.

No additional excavation

The Vario 800 flex shaft system can be directly installed in an EcoBloc infiltration or detention system. The connection surfaces of the inspection channels in the Vario 800 flex shaft system are accurately matched to the EcoBloc system.

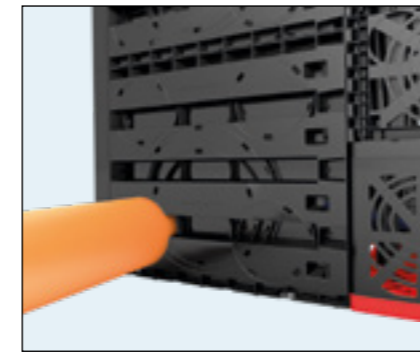
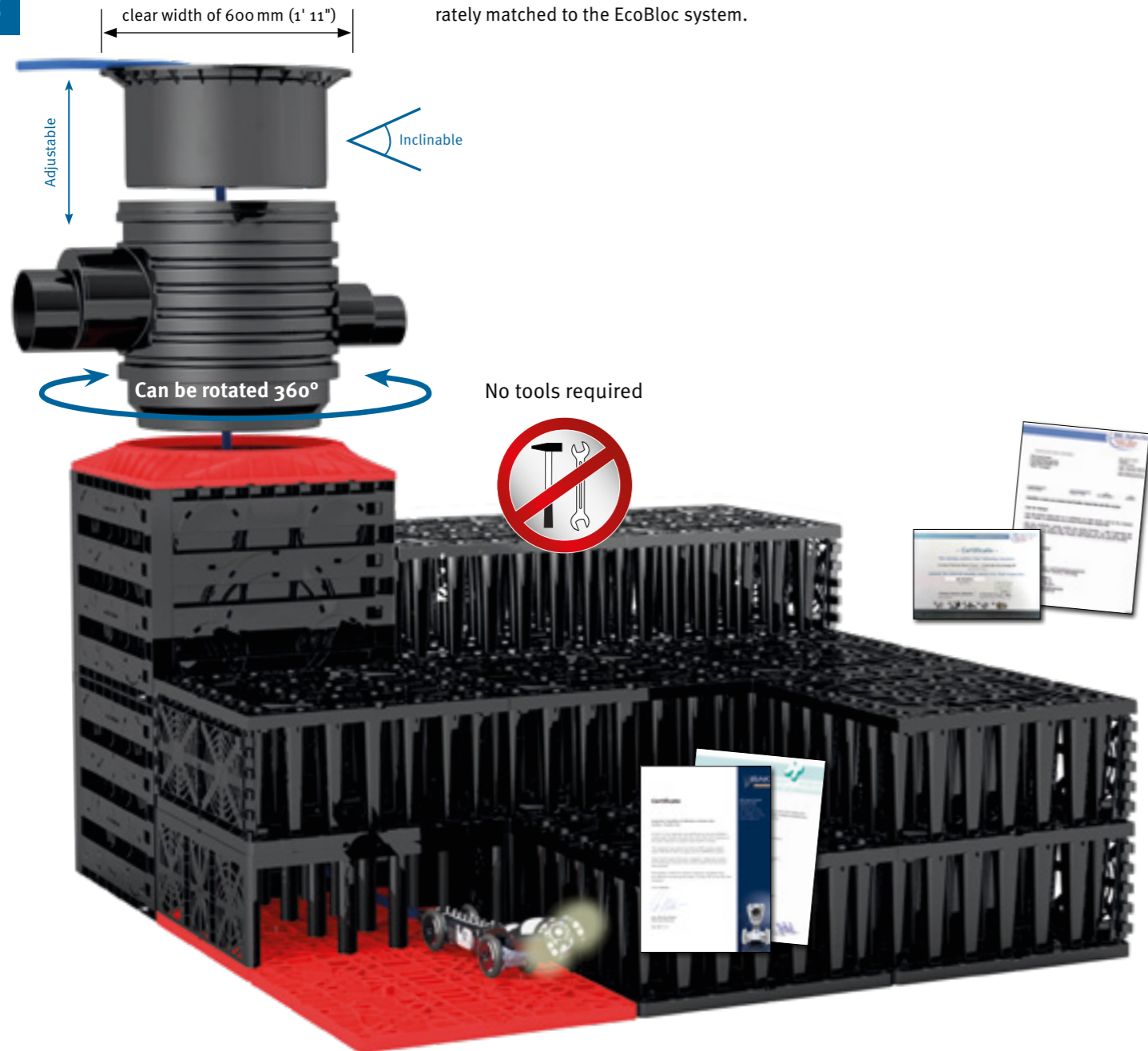

Connection surfaces up to DN 400 (16")

The Vario 800 comes with DN 200 (8"), DN 300 (12") and DN 400 (16") connection surfaces. The optional, freely rotating inlet module can be connected to pipes of sizes DN 150 (6"), DN 200 (8"), DN 250 (10") and DN 300 (12").

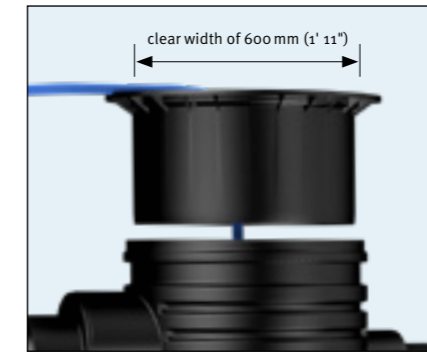

Wide access

The Vario 800 is terminated at the top by GRAF telescopic dome shafts. With a clear width of 600 mm, it gives easy access to the shaft. The base of the shaft itself is 800 x 800 mm (2' 7.5") x (2' 7.5") in size, providing sufficient space for all possible applications.

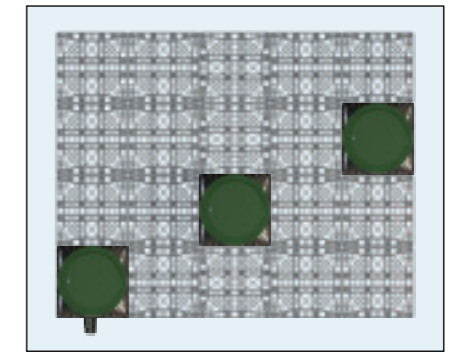

Can be positioned in any location

The dimensions of the Vario 800 shaft enable free positioning within the EcoBloc system. The corner position enables the connection of large pipe diameters of up to DN 400 (16") on the two side panels. The central position offers ideal access to the inspection camera from all directions. Using the optional inlet module, a connection of up to DN 300 (12") can be made with a freely defined angle.

Alignment of inspection channels

The inspection channels allow complete checking and rinsing of the entire infiltration ditch. The inspection channels must run parallel to the length of the ditch and form a continuous tunnel.

Access is normally via the end face DN 200 (8") connections of the Vario 800 shafts. The inspection camera enters through an inspection shaft. This is ideally created with the Vario 800 shaft system

and the two DN 200 (8") inlets. The open internal structure of the EcoBloc Inspect ditch elements permits very good illumination, making the infiltration system easier to inspect.

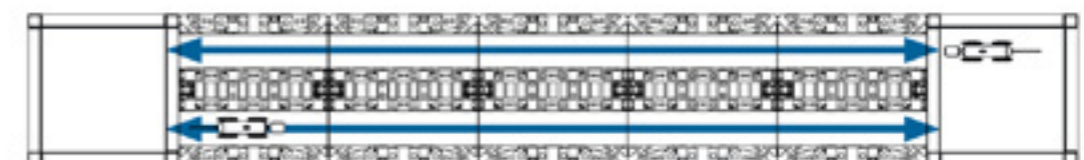
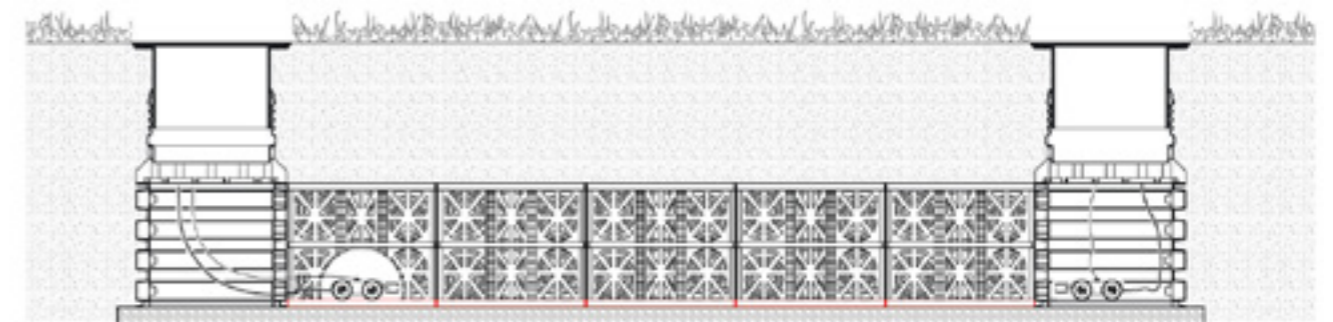

Vario 800 flex shaft



Vario 800 flex, type 1

shaft body for one or more layer of EcoBloc system

Volume	Length	Width	Height	Weight	Colour	Order no.
230 l (60.7 US gal.)	800 mm (2' 7.5")	800 mm (2' 7.5")	355 mm (1' 2")	16 kg (35.3 lbs)	grey	450050

Q Webcode G9303



Vario 800 flex, type 2

shaft body for two or more layer of EcoBloc system

Volume	Length	Width	Height	Weight	Colour	Order no.
420 l (113.5 US gal.)	800 mm (2' 7.5")	800 mm (2' 7.5")	660 mm (2' 2")	27 kg (59.5 lbs)	grey	450051

Vario 800 flex, base/cover set

base- and cover for Vario 800 flex shaft

Item	Colour	Order no.
set consisting out of Vario base- and cover plate	grey	450052



1. Stackable

To save space during transport and storage, the parts of the Vario 800 are stacked into each other. This minimizes transport costs and CO₂ emissions.

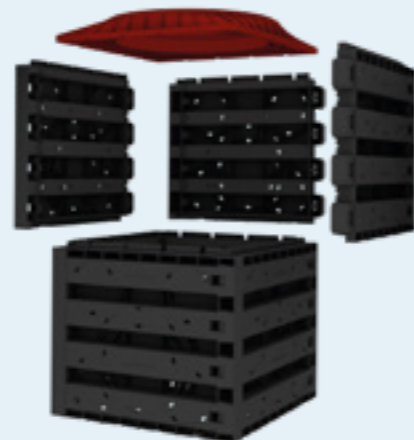

2. Easy installation

Groups of four wall elements are connected in a few simple steps and without tools to form a single height unit of the Vario 800. The height can be easily adjusted to the EcoBloc tank depth. A shaft cover and base plate complete the element.

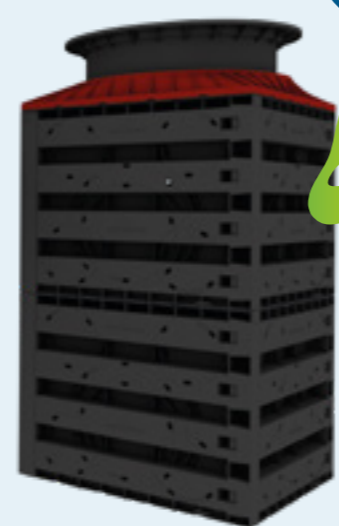

3. Ready

GRAF accessory components can now be added to the Vario 800 shaft as required.



Accessories

Shaft components

Infiltration filter strainer DN 600 (24")

Made entirely from stainless steel, mesh width 0.75 mm (0.03")

Order no. 340523



Infiltration inlet module DN 600 (24")

Incl. profile seal for telescopic dome shaft; DN 150 (6")/ DN 200 (8")/ DN 250 (10")/ DN 300 (12") connections

Order no. 330360



Infiltration connecting piece 1000 DN 600 (24")

With DN 200 (8") contact surface, incl. profile seal, length 1000 mm (3' 3.3"), 750 mm (2' 5.5"), 500 mm (1' 7.7")

Order no. 371015



Infiltration connecting piece 1000 DN 600 (24")

With DN 200 (8") pipe connections, incl. profile seal, length 1000 mm (3' 3.3"), 750 mm (2' 5.5"), 500 mm (1' 7.7")

Order no. 371016



Vario 800 film cover – PE

Fitted film for optimum welding of Vario shafts – material PE-LD 3 mm (0.1")

Order no. 450505



Vario 800 film cover – PVC

Fitted film for optimum PVC packaging of Vario shafts – material PVC 3 mm (0.1")

Order no. 450508



Retention accessories

Choke drain 1 DN 100 (4")

Includes emergency overflow, connector seal DN 100 (4") and PE-HD pipe for film welding; adjustable discharge 1.0 l (0.3 US gal.); 2.0 l (0.5 US gal.); 5.0 l (1.3 US gal.) and 6.5 l (1.7 US gal.)/s

Order no. 369005

Choke drain 2 DN 150 (6")

Includes emergency overflow, connector seal DN 150 (6") and PE-HD pipe for film welding; discharge adjustable from 2.0 l (0.5 US gal.) to 16 l (4.2 US gal.)/s

Order no. 369006



Choke drain pack 3 floating choke drains

Includes emergency overflow and PE-HD pipe for film welding; discharge adjustable from 0.05 l (0.01 US gal.) to 2 l (0.5 US gal.)/s

Order no. 369007

Tank Covers

Mini telescopic dome shaft

Suitable for pedestrian loading, height adjustable from 140 – 340 mm (5.5" – 13.4")

Order no. 371010



Maxi telescopic dome shaft

Suitable for pedestrian loading, height adjustable from 140 – 440 mm (5.5" – 17.3")

Order no. 371011



Cast iron telescopic dome shaft

Suitable for vehicle loading, height adjustable from 140 – 440 mm (5.5" – 17.3")

Order no. 371020



Telescopic dome shaft lorry

Suitable for lorry-bearing loading, height adjustable from 140 – 440 mm (5.5" – 17.3")

Order no. 371021

Cover and compensating ring to be provided on site



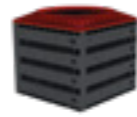

Infiltration module	Vario 800 flex type 1/type 2	EcoBloc Inspect flex	
Gross volume	230 l (60.7 US gal.) / 420 l (113.5 US gal.)	A 205 l (54.2 US gal.)	
Net volume		D 195 l (51.5 US gal.)	
Storage coefficient	100%	96%	
Inspectable	•	•	
High pressure jetting possible	•	•	
Load			
Load	Short-term	max. 100 kN/m ²	max. 100 kN/m ²
	Long-term	max. 59 kN/m ²	max. 59 kN/m ²
Without traffic load	min. earth covering	250 mm (9.8")	250 mm (9.8")
	max. earth covering	2750 mm (9')	2750 mm (9')
	max. installation depth	5000 mm (16' 4.8")	5000 mm (16' 4.8")
	max. number of layers	14	14
	min. earth covering	250 mm (9.8")	250 mm (9.8")
Vehicle	max. earth covering	2750 mm (9')	2750 mm (9')
	max. installation depth	5000 mm (16' 4.8")	5000 mm (16' 4.8")
	max. number of layers	14	14
	min. earth covering	500 mm (1' 7.7")	500 mm (1' 7.7")
Lorry 12/H-10/H-15	max. earth covering	2750 mm (9')	2750 mm (9')
	max. installation depth	5000 mm (16' 4.8")	5000 mm (16' 4.8")
	max. number of layers	13	13
	min. earth covering	500 mm (1' 7.7")	500 mm (1' 7.7")
Lorry 30	max. earth covering	2500 mm (8' 2.4")	2500 mm (8' 2.4")
	max. installation depth	5000 mm (16' 4.8")	5000 mm (16' 4.8")
	max. number of layers	13	13
	min. earth covering	500 mm (1' 7.7")	500 mm (1' 7.7")
Lorry 40/HS-20	max. earth covering	2250 mm (7' 4.5")	2250 mm (7' 4.5")
	max. installation depth	5000 mm (16' 4.8")	5000 mm (16' 4.8")
	max. number of layers	13	13
	min. earth covering	800 mm (2' 7.5")	800 mm (2' 7.5")
Lorry 60/HS-25	max. earth covering	2000 mm (6' 6.7")	2000 mm (6' 6.7")
	max. installation depth	5000 mm (16' 4.8")	5000 mm (16' 4.8")
	max. number of layers	13	13
	min. earth covering	800 mm (2' 7.5")	800 mm (2' 7.5")
Connections			
DN 100 (4")		•	
DN 150 (6")		•	
DN 200 (8")	•	•	
DN 250 (10")		•	
DN 300 (12")	•	• ^{1),2)}	
DN 400 (16")	•	• ^{1),2)}	
DN 500 (20")		• ²⁾	
Measurements			
Length	800 mm (2' 7.5")	800 mm (2' 7.5")	
Width	800 mm (2' 7.5")	800 mm (2' 7.5")	
Height	320 mm (1' 0.6") / 660 mm (2' 2.0")	320 mm (1' 0.6")	
Weight	16 kg (35.3 lbs) / 27 kg (59.5 lbs)	8 kg (17.6 lbs)	

¹⁾ Optionally available with Vario shaft

²⁾ Optionally available with adaptor plates



	EcoBloc maxx	EcoBloc flex / maxx	EcoBloc light	EcoBloc flex / light
B	225 l (59.4 US gal.)	A + B	C 225 l (59.4 US gal.)	A + C
E	217 l (57.3 US gal.)	D + E	F 219 l (57.9 US gal.)	D + F
	96%	96%	97%	96 – 97%
		•		•
		•		•
	max. 100 kN/m ²	max. 85 kN/m ²	max. 75 kN/m ²	max. 53 kN/m ²
	max. 59 kN/m ²	max. 50 kN/m ²	max. 41 kN/m ²	max. 31 kN/m ²
	250 mm (9.8")	500 mm (1' 7.7")	250 mm (9.8")	250 mm (9.8")
	2750 mm (9')	2000 mm (6' 6.7")	1750 mm (5' 8.9")	1250 mm (4' 1.2")
	5000 mm (16' 4.8")	5000 mm (16' 4.8")	4000 mm (13' 1.4")	4000 mm (13' 1.4")
	13	12	10	10
	250 mm (9.8")	500 mm (1' 7.7")	500 mm (1' 7.7")	500 mm (1' 7.7")
	2750 mm (9')	2000 mm (6' 6.7")	1750 mm (5' 8.9")	1250 mm (4' 1.2")
	5000 mm (16' 4.8")	5000 mm (16' 4.8")	4000 mm (13' 1.4")	4000 mm (13' 1.4")
	13	12	9	9
	500 mm (1' 7.7")	800 mm (2' 7.5")	800 mm (2' 7.5")	800 mm (2' 7.5")
	2750 mm (9')	2000 mm (6' 6.7")	1750 mm (5' 8.9")	1250 mm (4' 1.2")
	5000 mm (16' 4.8")	5000 mm (16' 4.8")	4000 mm (13' 1.4")	4000 mm (13' 1.4")
	12	12	9	9
	500 mm (1' 7.7")	800 mm (2' 7.5")	800 mm (2' 7.5")	800 mm (2' 7.5")
	2500 mm (8' 2.4")	1750 mm (5' 8.9")	1750 mm (5' 8.9")	1750 mm (5' 8.9")
	5000 mm (16' 4.8")	5000 mm (16' 4.8")	5000 mm (16' 4.8")	5000 mm (16' 4.8")
	12	11	11	11
	800 mm (2' 7.5")	800 mm (2' 7.5")	800 mm (2' 7.5")	800 mm (2' 7.5")
	2250 mm (7' 4.5")	1500 mm (4' 11")	1500 mm (4' 11")	1500 mm (4' 11")
	5000 mm (16' 4.8")	5000 mm (16' 4.8")	5000 mm (16' 4.8")	5000 mm (16' 4.8")
	11	11	11	11
	800 mm (2' 7.5")	800 mm (2' 7.5")	800 mm (2' 7.5")	800 mm (2' 7.5")
	800 mm (2' 7.5")	800 mm (2' 7.5")	800 mm (2' 7.5")	800 mm (2' 7.5")
	350 mm (1' 1.8")	750 mm (2' 5.5")	350 mm (1' 1.8")	750 mm (2' 5.5")
	9 kg (19.8 lbs)	7 kg (15.4 lbs)	7 kg (15.4 lbs)	7 kg (15.4 lbs)

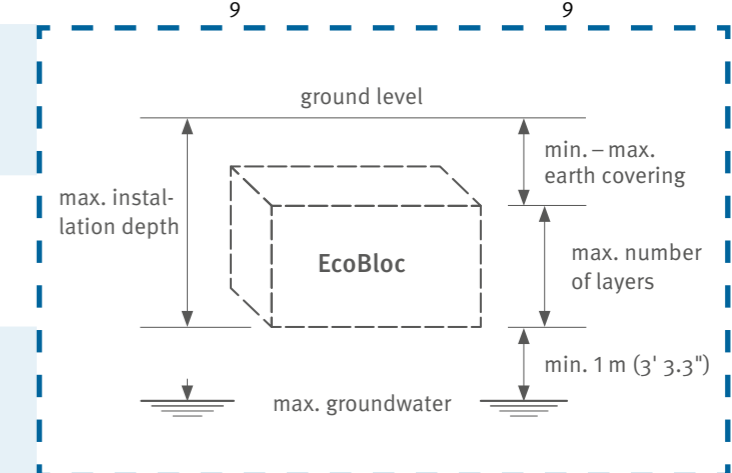

Infiltration with EcoBloc maxx

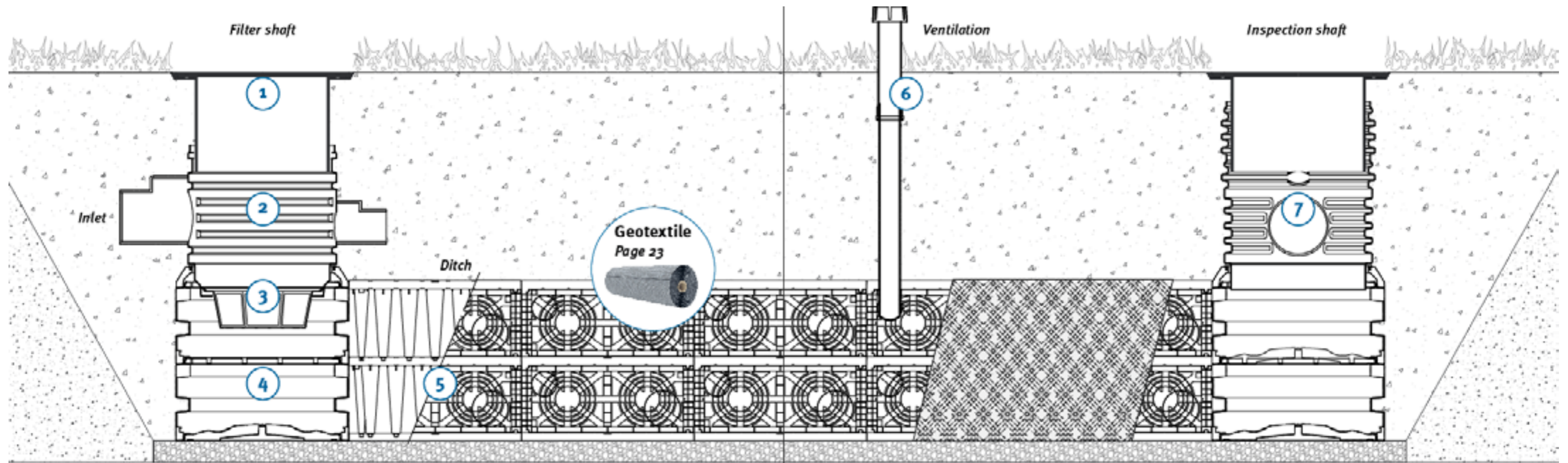

1 Telescopic dome shaft



- Choice of pedestrian, car or HGV loading

Page 27

2 Infiltration inlet module DN 600 (24")



- Freely rotatable for optimum alignment to connecting line
- Connections up to DN 300 (12")

Page 27

3 Infiltration filter strainer



- Stainless steel filter (mesh width 0.75 mm (0.03"))
- Reliably filters out contamination

Page 27

4 Vario 800 flex, type 2



- Optimally aligned to EcoBloc Inspect flex
- Wide range of possible shaft solutions
- Connections up to DN 400 (16")

Page 26

5 EcoBloc maxx



- Lorry-bearing 40 tons/HS-20
- 410 m³ (108,310 US gal.)/Truck

Page 22

6 Deaeration end



- DN 100 (4")
- For separate ventilation
- For installation in green spaces

Page 23

7 Infiltration connecting piece 1000 DN 600 (24")



- For greater installation depths

Page 27

Swale infiltration with EcoBloc light

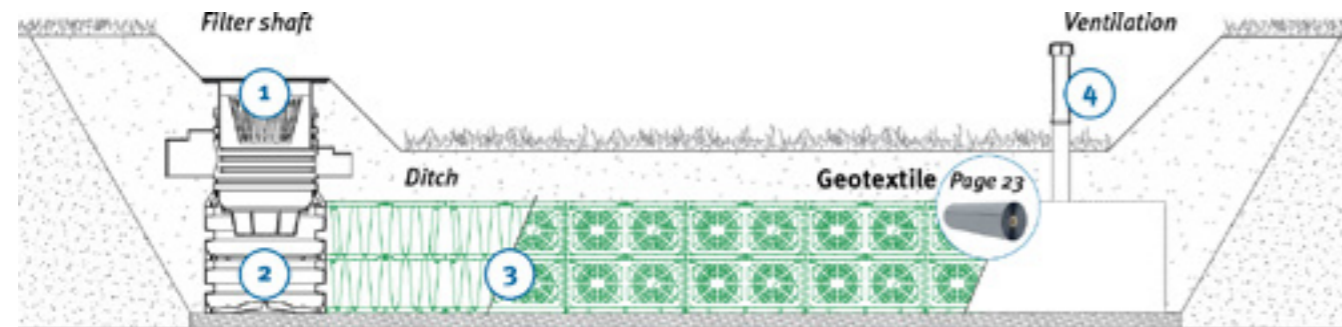

1 Telescopic filter shaft 600



- Choice of pedestrian, car or HGV loading

Upon request

2 Vario 800 flex, type 1

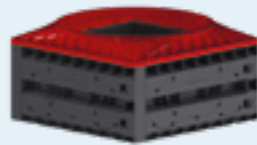

- Optimally aligned to EcoBloc Inspect flex
- Wide range of possible shaft solutions
- Connections up to DN 400 (16")

Page 26

3 EcoBloc light

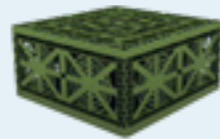

- Lorry-bearing 12 tons
- 610 m³ (161,145 US gal.)/Truck

Page 23

4 Deaeration end



- DN 100 (4")
- For separate ventilation
- For installation in green spaces

Page 23

Retention and rainwater harvesting with EcoBloc Inspect flex and maxx

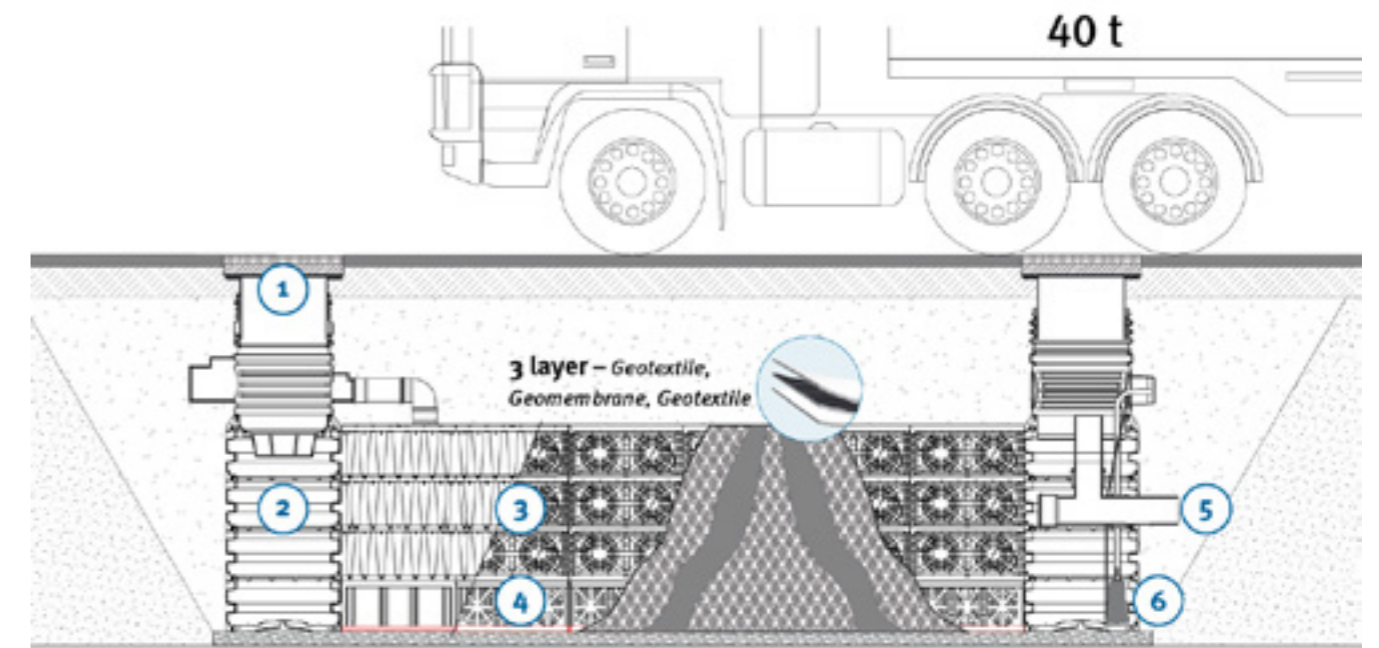

1 Telescopic dome shaft lorry



- Lorry-bearing up to 60 tons
- Cover and compensating ring to be provided on site

Page 27

2 Vario 800 flex, type 2

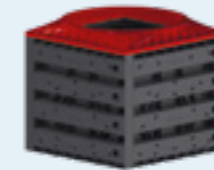

- Optimally aligned to EcoBloc Inspect flex
- Wide range of possible shaft solutions
- Connections up to DN 400 (16")

Page 26

3 EcoBloc maxx

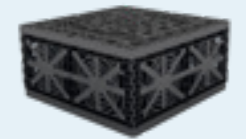

- Lorry-bearing 40 tons/HS-20
- 410 m³ (108,310 US gal.)/Truck

Page 22

4 EcoBloc Inspect flex

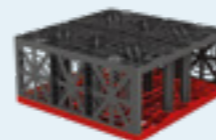

- Lorry-bearing 60 tons/HS-25
- 150 m³ (39,600 US gal.)/Truck
- Inspectable
- High pressure jetting possible

Page 22

5 Choke drain



- Available from 0.05 l (0.01 US gal.) to 16 l (4.2 US gal.)/s
- Optimised for use in the Vario 800 shaft

Page 27

6 Submersible pump



You can find pumps and other products for rainwater harvesting in our catalogue, "Rainwater harvesting solutions"

Firefighting water with EcoBloc Inspect flex

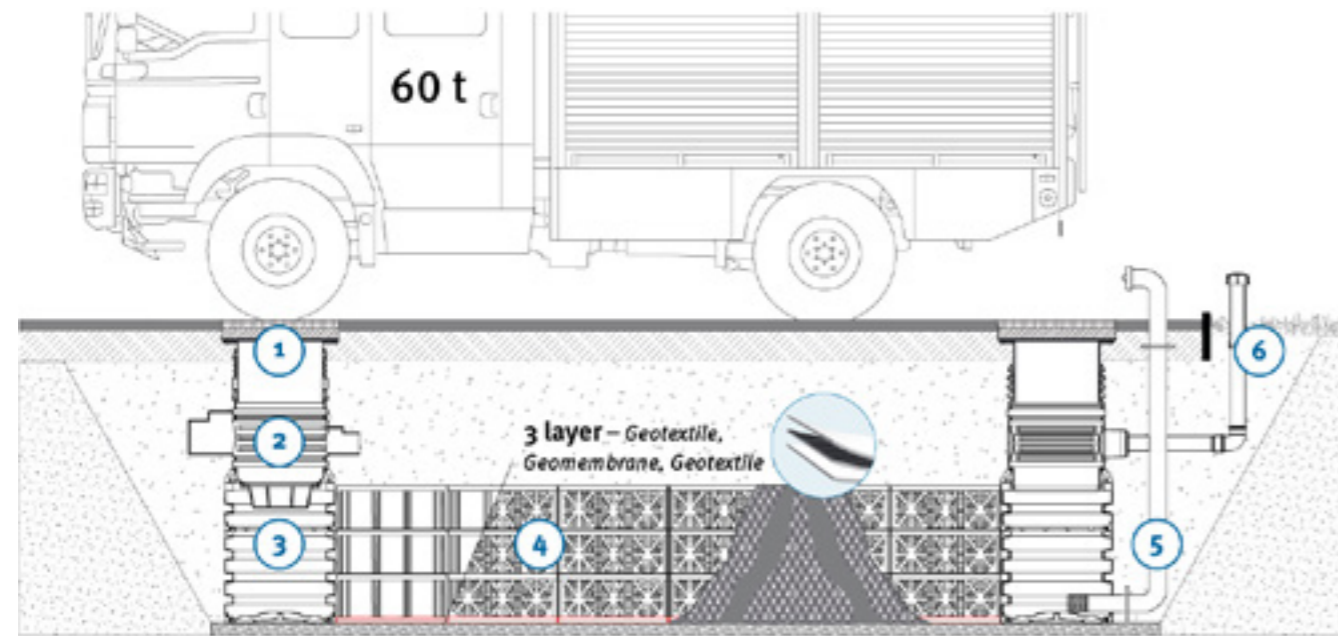

1 Telescopic dome shaft lorry



- Lorry-bearing up to 60 tons
- Cover and compensating ring to be provided on site

Page 27

2 Infiltration inlet module DN 600 (24")



- Freely rotatable for optimum alignment to connecting line
- Connections up to DN 300 (12")

Page 27

3 Vario 800 flex, type 2

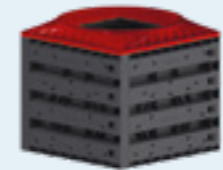

- Optimally aligned to EcoBloc Inspect flex
- Wide range of possible shaft solutions
- Connections up to DN 400 (16")

Page 26

4 EcoBloc Inspect flex



- Lorry-bearing 60 tons/HS-25
- 150 m³ (39,600 US gal.)/Truck
- Inspectable
- High pressure jetting possible

Page 22

5 Firefighting water accessories



- Suction connection and ventilation integrated in the shaft
- High-quality stainless steel components

Upon request

6 Deaeration end accessories



- DN 100 (4")
- For separate ventilation
- For installation in green spaces

Page 23

Rainwater harvesting with EcoBloc Inspect flex and light

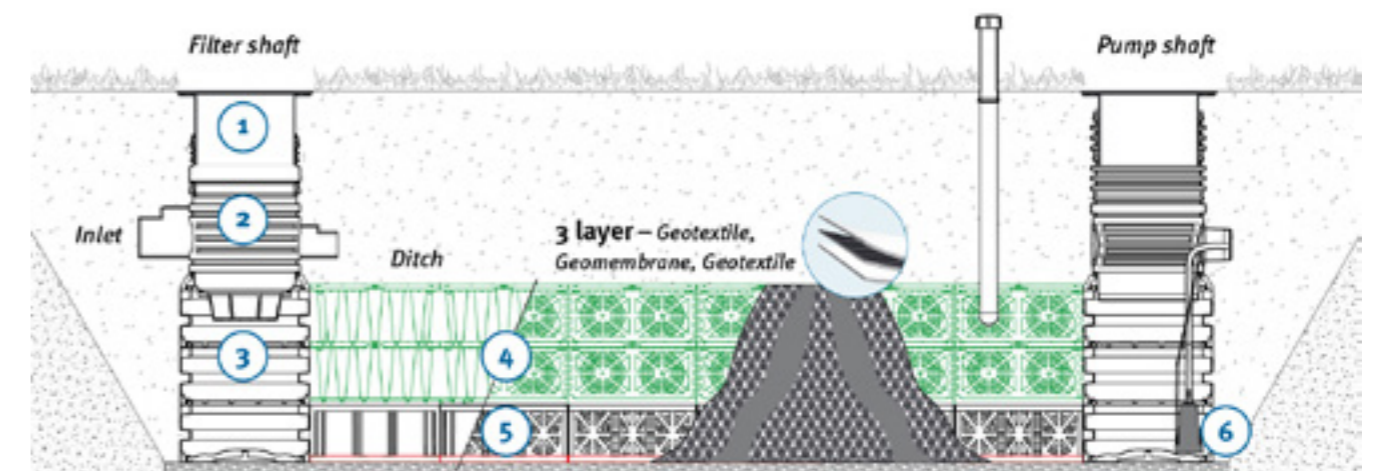

1 Telescopic dome shaft



- Choice of pedestrian, car or HGV loading

Page 27

2 Infiltration inlet module DN 600 (24")



- Freely rotatable for optimum alignment to connecting line
- Connections up to DN 300 (12")

Page 27

3 Vario 800 flex, type 2

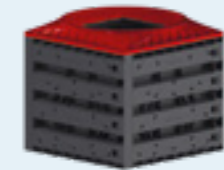

- Optimally aligned to EcoBloc Inspect flex
- Wide range of possible shaft solutions
- Connections up to DN 400 (16")

Page 26

4 EcoBloc light



- Lorry-bearing 12 tons
- 610 m³ (161,145 US gal.)/Truck

Page 23

5 EcoBloc Inspect flex



- Lorry-bearing 60 tons/HS-25
- 150 m³ (39,600 US gal.)/Truck
- Inspectable
- High pressure jetting possible

Page 22

6 Submersible pump



You can find pumps and other products for rainwater harvesting in our catalogue, "Rainwater harvesting solutions"



Infiltration

Infiltration Tunnel / twin

The logistical miracle – can be laid in rows



Stormwater management ▶ Infiltration Tunnel / twin

Stormwater management ▶ Infiltration Tunnel / twin



Easy installation

The GRAF Infiltration Tunnels are laid in lines and can be flexibly adapted to specific conditions and to the individual storage volume requested. The installation of the modules is easy, quick and variable. The installation is possible without heavy equipment, as one Infiltration Tunnel only weighs 11 gram (24.3 lbs). The tunnel modules are simply stuck together in one line and equipped with 2 end plates per line.



300 l Volume

The compact dimensions combined with a storage coefficient of 100 % result in a useful volume of 300 l (79 US gal.).

Lorry-bearing up to 60 tons

In order to enable the free arrangement of surfaces above it, the Infiltration Tunnel features long-term resistance with 59 kN/m² (Infiltration Tunnel twin 35 kN/m²) and is therefore lorry-bearing.

100 % storage volume

The typical shape of the Infiltration Tunnel enables complete utilisation of the available volume for the temporary storage of rainwater.



Infiltration Tunnel twin – Twice the volume with the same space requirement

Upon request, the Infiltration Tunnel twin 600 litres (158 US gal.) offers volume through the connection of two identical Infiltration Tunnel modules.



Connections up to DN 300 (12")

Large infiltration volumes require large pipe diameters. For the GRAF Infiltration Tunnel, this is not a problem: each end plate features connections in the sizes DN 100 (4"), 150 (6"), 200 (8") and 300 (12"). In addition, connections in the sizes DN 100 (4") and 200 (8") are provided on the upper surface for the connection of a ventilation system or an inspection opening.



Up to 12,000 litres infiltration volume per pallet

Thanks to its special design, the GRAF Infiltration Tunnel can be stacked easily. Consequently, the shipment of up to 40 Infiltration Tunnels on one pallet saves considerable transport and storage costs.



High infiltration performance

The ditch elements are placed directly upon an even layer of gravel. The sides are then covered with geotextile and the end faces are closed using end plates. This installation and the side slats ensure a permanent high infiltration performance.

Installation depth of over 4 metres (13' 1.5")

The GRAF Infiltration Tunnel can be installed at a depth of up to 4.25 metres (13' 11"), even under heavy loads. The maximum installation depth for the Infiltration Tunnel twin is 2.5 metres (8' 2.4").



Infiltration Tunnel / twin Ditch system



Infiltration ditch body



Infiltration ditch body accessories



Shaft



Shaft accessories

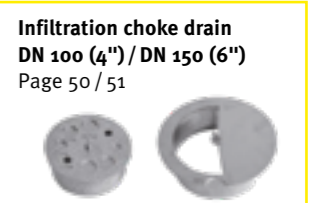
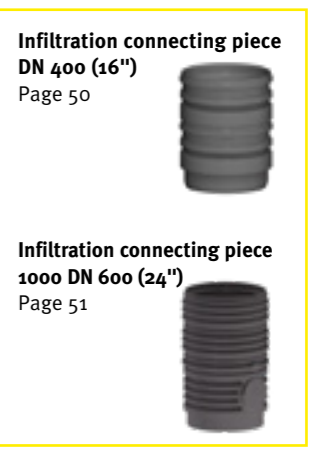
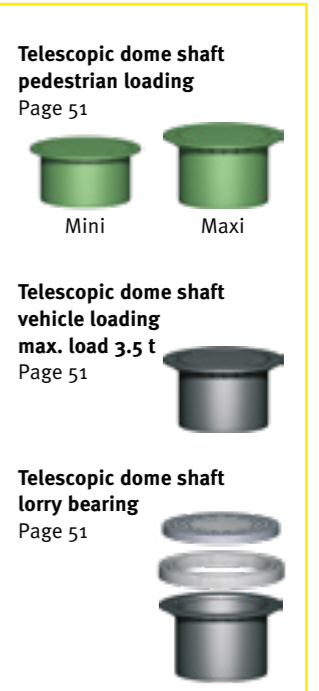

Infiltration Tunnel / twin



Stormwater management ▶ Infiltration Tunnel / twin

Stormwater management ▶ Infiltration Tunnel / twin



Infiltration Tunnel lorry

Volume	Length	Width	Height	Weight	Colour	Order no.
300 l (79 US gal.)	1160 mm (45.7")	800 mm (31.5")	510 mm (20")	11 kg (24.4 lbs)	black	230010

Q Webcode G4103



Infiltration Tunnel twin car

Consisting of two tunnels and 1 set of click-bolt connectors

Volume	Length	Width	Height	Weight	Colour	Order no.
600 l (158 US gal.)	1160 mm (45.7")	800 mm (31.5")	1020 mm (40")	22 kg (48.8 lbs)	black	410130

Q Webcode G4104



End plate for Infiltration Tunnel / twin

Item	Colour	Order no.
End plates (Set of 2 units)	black	231004

Infiltration module	Infiltration Tunnel lorry	Infiltration Tunnel twin car	
Gross / net volume	300 litres (79 US gal.)	600 litres (158 US gal.)	
Load			
Load	Short-term	max. 100 kN/m ²	max. 75 kN/m ²
	Long-term	max. 59 kN/m ²	max. 35 kN/m ²
Without traffic load	min. earth covering	250 mm (9.8")	250 mm (9.8")
	max. earth covering	3750 mm (12' 3.2")	1500 mm (4' 10.3")
	max. installation depth	4250 mm (13' 11.3")	2500 mm (8' 2.4")
Vehicle	min. earth covering	250 mm (9.8")	500 mm (16.7")
	max. earth covering	3500 mm (11' 5.4")	1500 mm (4' 10.3")
	max. installation depth	4000 mm (13' 1.5")	2500 mm (8' 2.4")
Lorry 12/H-10/H-15	min. earth covering	500 mm (16.7")	
	max. earth covering	3250 mm (10' 7.5")	
	max. installation depth	3750 mm (12' 3.6")	
Lorry 30	min. earth covering	500 mm (16.7")	
	max. earth covering	2750 mm (10' 7.6")	
	max. installation depth	3250 mm (10' 8")	
Lorry 40/HS-20	min. earth covering	500 mm (16.7")	
	max. earth covering	2500 mm (8' 2")	
	max. installation depth	3000 mm (9' 10.1")	
Lorry 60/HS-25	min. earth covering	750 mm (29.5")	
	max. earth covering	1750 mm (5' 8.5")	
	max. installation depth	2250 mm (7' 4.6")	

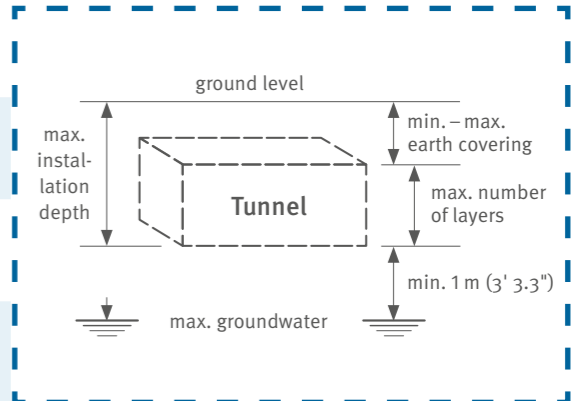

Connections on front

DN 100 (4")	2 x	4 x
DN 150 (6")	1 x	2 x
DN 200 (8")	1 x	2 x
DN 300 (12")	1 x	2 x

Connections on top

DN 100 (4")	1 x	1 x
DN 200 (8")	1 x	1 x

Measurements

Length	1160 mm (45.7"), 1220 mm (48") (incl. end plates)	
Width	800 mm (2' 7.5")	
Height	510 mm (24")	1020 mm (48")
Weight	approx. 11 kilos (24.2 lbs)	approx. 2 x 11 kilos (2 x 24.2 lbs)

Infiltration Tunnel / twin accessories

Inspection end

DN 200 (8")
Order no. 340527



Deaeration end

DN 100 (4")
Order no. 369017



GRAF-Tex geotextile

For one Infiltration Tunnel
Size of 2.50 x 2.50 m (8' 2.4" x 8' 2.4")
Order no. 231006



GRAF click-bolt connectors

Connector for Infiltration Tunnel twin (set of 6 for one Infiltration Tunnel twin car)
Order no. 410094



Sold by the metre, roll width 5 m (16' 4.8")
Order no. 231002

Sold by the metre, roll width 2,5 m (8' 2.4")
Order no. 231007

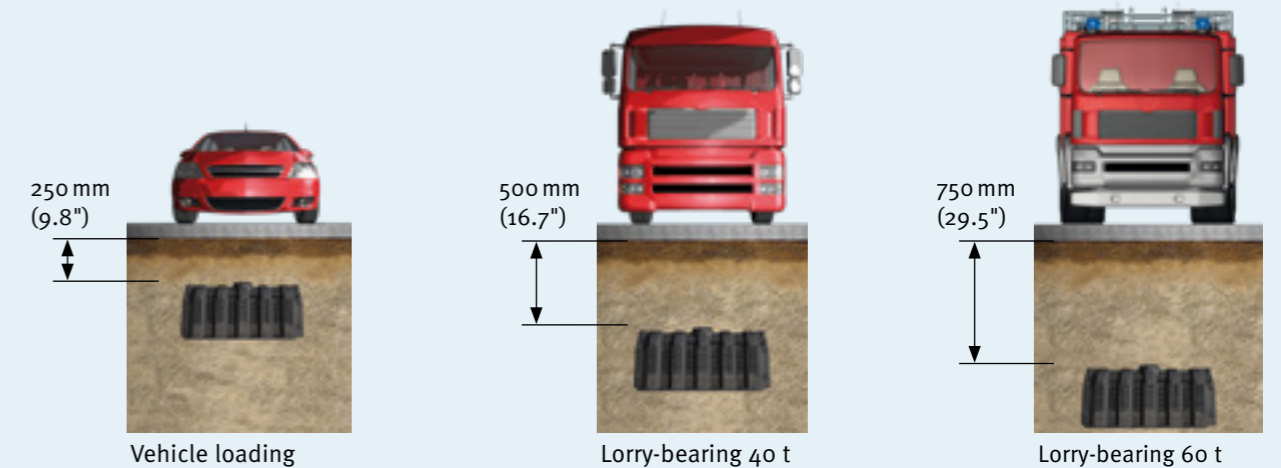

Infiltration Tunnel / twin

Areas of application



Stormwater management ▶ Infiltration Tunnel / twin

Stormwater management ▶ Infiltration Tunnel / twin

Ditch infiltration with Infiltration Tunnel

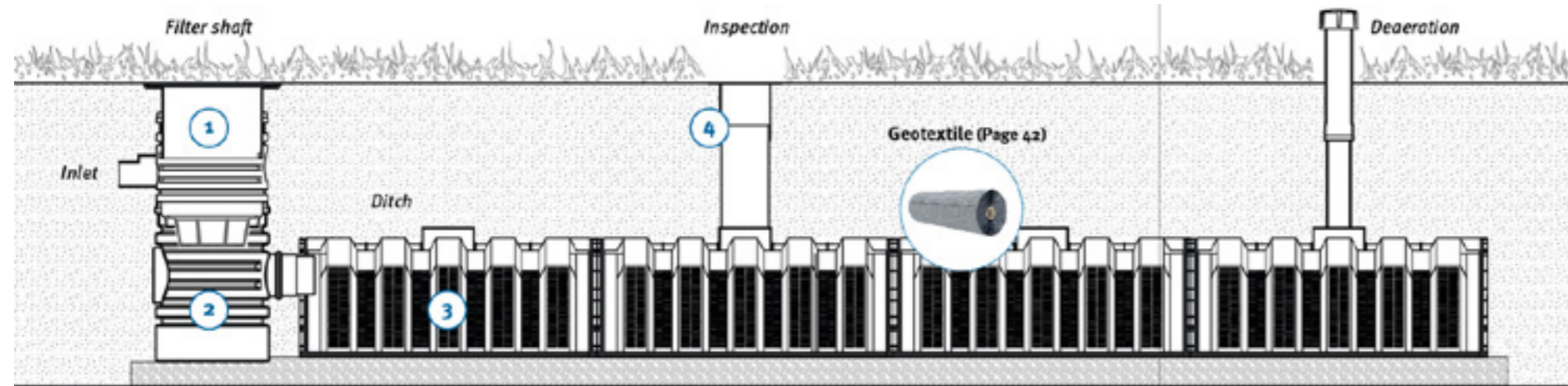

1 Telescopic dome shaft



- Choice of pedestrian, car or HGV loading

Page 51

2 Infiltration shaft DN 400 (16")



- 2 x DN 150 (6")
- For connections of up to DN 150 (6")

Page 50

3 Infiltration Tunnel



- The logistical miracle – can be laid in rows

Page 42

4 Inspection end



- DN 200 (8")

Page 42

Combined rainwater harvesting and infiltration with Infiltration Tunnel

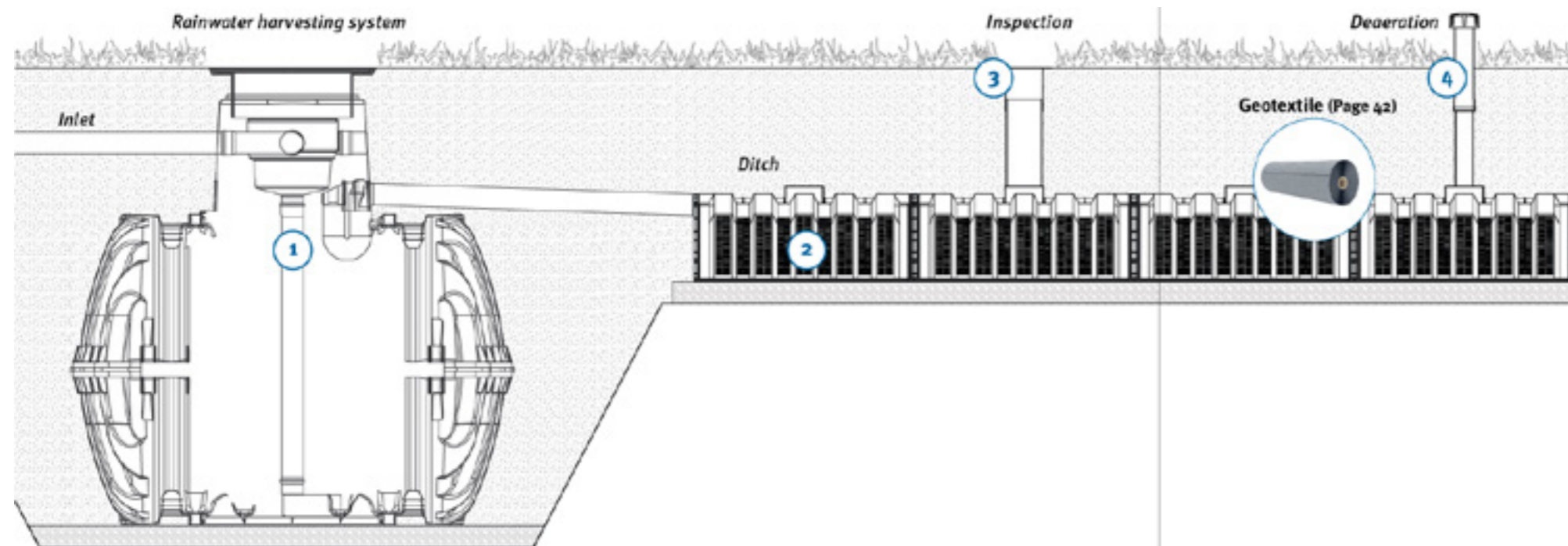

1 Rainwater harvesting

You can find more information about our Carat S Rainwater tank in our catalogue, "Rainwater harvesting solutions"



2 Infiltration Tunnel



- The logistical miracle – can be laid in rows

Page 42

3 Inspection end



- DN 200 (8")

Page 42

4 Deaeration end



- DN 100 (4")
- For separate ventilation

Page 42

Infiltration Tunnel / twin

Areas of application



Stormwater management ▶ Infiltration Tunnel / twin

Ditch infiltration with Infiltration Tunnel twin

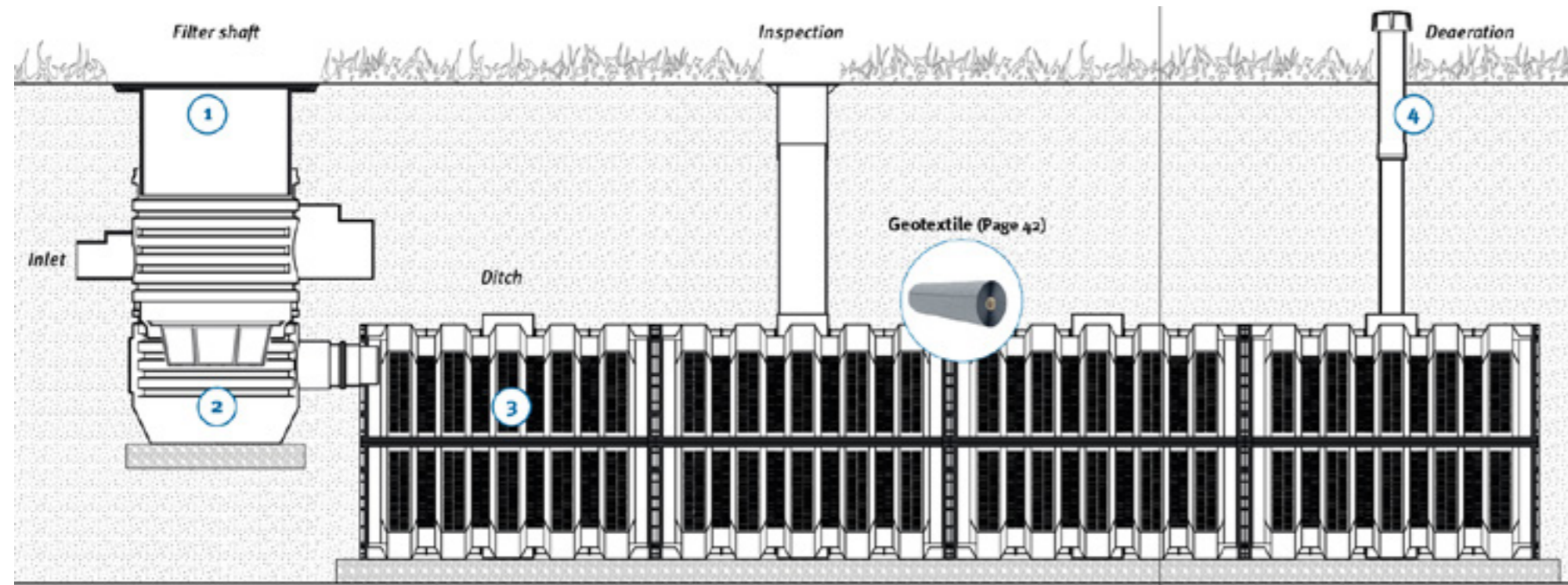

1 Telescopic dome shaft



- Choice of pedestrian, car or HGV loading

Page 51

2 Infiltration shaft DN 600 (24")



- 2 x DN 150 (6")
- For connections of up to DN 150 (6")

Page 51

3 Infiltration Tunnel twin



- Twice the volume with the same space requirement

Page 42

4 Deaeration end



- DN 100 (4")
- For separate ventilation

Page 42

Combined wastewater treatment and infiltration with Infiltration Tunnel

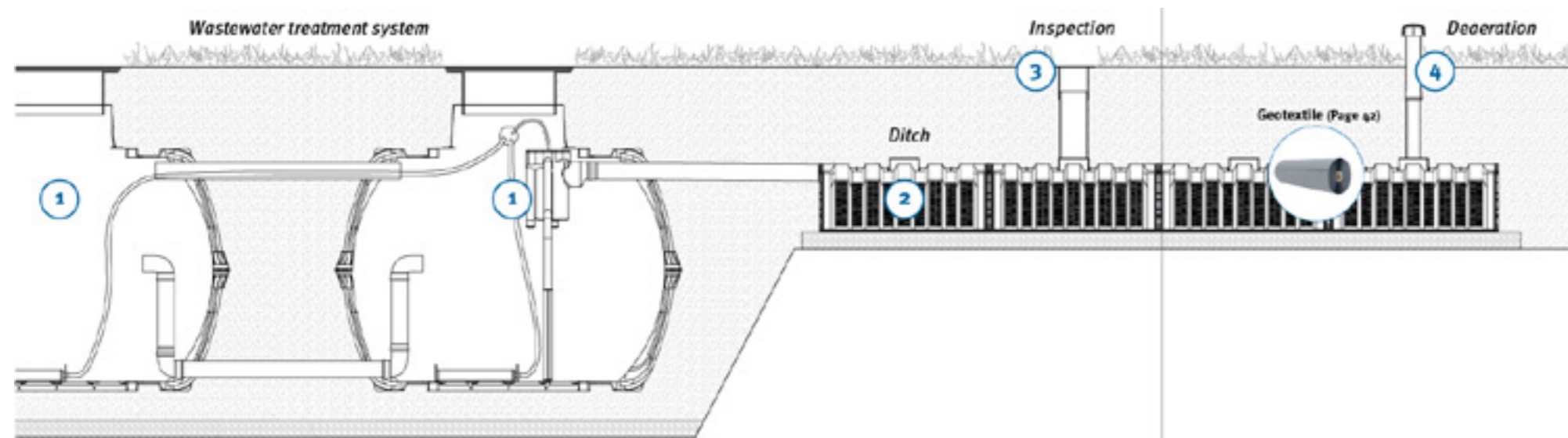

1 Wastewater treatment

You can find more information about wastewater treatment in our catalogue, "Wastewater Treatment Solutions"

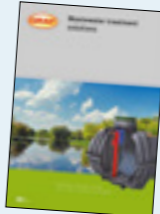

Page 42

2 Infiltration Tunnel



- The logistical miracle – can be laid in rows

Page 42

3 Inspection end



- DN 200 (8")

Page 42

4 Deaeration end



- DN 100 (4")
- For separate ventilation

Page 42

Stormwater management ▶ Infiltration Tunnel / twin



Infiltra

Filters and shafts	Vario 800 flex	Infiltration shaft system DN 400	Infiltration shaft system DN 600	Universal industrial external 3	Universal filter 3 external	Infiltration filter shaft	Settling filter shaft
Dimension	800 x 800 mm (31.4" x 31.4")	Ø 400 mm (15.7")	Ø 600 mm (23.6")	Ø 600 mm (23.6")	Ø 400 mm (15.7")	Ø 600 mm (23.6")	Ø 400 mm (15.7")
Loading class							
	•	•	•	•	•	•	•
	•	•	•	•	•	•	•
	•	•	•	•	o	o	o
Connection options / flow rates							
DN 100 (4")	—	5.5 l/sec.	5.5 l/sec.	—	5.5 l/sec.	5.5 l/sec.	5.5 l/sec.
DN 150 (6")	—	16 l/sec.	16 l/sec.	16 l/sec.	16 l/sec.	16 l/sec.	16 l/sec.
DN 200 (8")	29.5 l/sec.	29.5 l/sec.	29.5 l/sec.	29.5 l/sec.	—	—	—
DN 250 (10")	—	—	55 l/sec.	—	—	—	—
DN 300 (12")	99 l/sec.	—	99 l/sec.	—	—	—	—
DN 400 (16")	175 l/sec.	—	—	—	—	—	—
Filter type	B	A or C	B	B	A	A and C	D
Function of shafts							
Filter shaft	•	•	•	•	•	•	•
Sedimentation shaft	—	—	—	—	—	•	•
Inspection shaft	•	•	•	—	—	—	—
Choke shaft	•	•	•	—	—	—	—
Pump shaft	•	•	•	—	—	—	—
Catalogue page	Page 26	Page 50	Page 51	Page 52	Page 52	Page 53	Page 53

Filter type	Material	Mesh width	Soil volume	Note
Filter type A Filter basket DN 400 (16")	PP	0.35 mm (0.01")	15 l (4 US gal.)	with lifting device
Filter type B Infiltration filter strainer DN 600 (24")	Stainless steel	0.75 mm (0.03")	25 l (6.6 US gal.)	with lifting device
Filter type C Telescopic filter basket	galvanised PP	< 0.50 mm (0.02") 0.35 mm (0.01")	20 l (5.3 US gal.)	Coarse filter with lifting device Fine filter
Filter type D Settling filter basket	PP	0.35 mm (0.01")	17 l (4.5 US gal.)	with lifting device

Infiltration shaft system DN 400 (16")



Covers



Telescopic dome shaft 400
With PE cover, suitable for pedestrian loading, colour: grass green
Order no. 340053



Telescopic dome shaft 400
With cast iron cover, suitable for vehicle loading max. load 3.5 t, colour: black
Order no. 340054



Telescopic dome shaft 400
With cast iron cover, lorry-bearing max. load 60 t, colour: black
Order no. 340049



Telescopic filter shaft 400
With slotted cast iron cover, suitable for vehicle loading max. load 3.5 t, incl. coarse filter insert and fine filter basket (0.35 mm (0.01") mesh width), colour: black
Order no. 340126



Infiltration shaft system DN 600 (24")

Covers



Telescopic dome shaft Mini
With PE cover, suitable for pedestrian loading, colour: grass green
Order no. 371010



Telescopic dome shaft cast iron
With cast iron cover, suitable for vehicle loading max. load 3.5 t, colour: black
Order no. 371020



Telescopic dome shaft Maxi
With PE cover, suitable for pedestrian loading, colour: grass green
Order no. 371011



Telescopic dome shaft lorry
For common concrete rings, lorry-bearing max. load 60 t, colour: black
Order no. 371021



Individual components



Infiltration inlet module DN 400 (16")
Incl. profile seal for telescopic dome shaft; DN 150 (6")/DN 200 (8") connections
Order no. 330339

Infiltration filter basket DN 400 (16")
Mesh width 0.35 mm (0.01")
Order no. 340524



Infiltration connecting piece DN 400 (16")
To produce greater installation depths, effective length: 500 mm (19.7"), can be shortened to 250 mm (9.8")
Order no. 330341

Retention accessories

Infiltration choke drain
Connection DN 100 (4"); delayed drain of 1.0 (0.3 US gal.)/sec. up to 6.5 l (1.7 US gal.)/sec.
Order no. 330547



[Q Webcode G9301](#)

Individual components



Infiltration inlet module DN 600 (24")
Incl. profile seal for telescopic dome shaft; DN 150 (6")/DN 200 (8")/DN 250 (10")/DN 300 (12") connections
Order no. 330360

Infiltration filter strainer DN 600 (24")
Made entirely from stainless steel, mesh width 0.75 mm (0.03")
Order no. 340523



Infiltration connecting piece 1000 DN 600 (24")
With DN 200 (8") contact surface, incl. profile seal, length 1000 mm (3' 3.3"), 750 mm (2' 5.5"), 500 mm (1' 7.7")
Order no. 371015

Infiltration connecting piece 1000 DN 600 (24")
With DN 200 (8") pipe connections, incl. profile seal, length 1000 mm (3' 3.3"), 750 mm (2' 5.5"), 500 mm (1' 7.7")
Order no. 371016



Infiltration distributor module DN 600 (24")
Incl. profile seal for infiltration connecting piece and/or inlet module; 2 x DN 150 (6") connections; mounting surface for connections of up to DN 150 (6")
Order no. 330361

Retention accessories

Infiltration choke drain
Connection DN 150 (6"); delayed drain of 2 l (0.5 US gal.)/sec. up to 16 l (4.2 US gal.)/sec.
Order no. 330598



[Q Webcode G9302](#)

Universal filter

Universal filter 3 external

- 100 % water yield therefore ideal for smaller roof areas
- Filter insert mesh width 0.35 mm (0.01")
- Continuously variable installation depth of 600 mm – 1050 mm (22.4 – 41.3") using the telescopic dome shaft
- Lockable, childproof cover
- Flush with ground level
- Minimal height offset 270 mm (10.6") between the inlet and outlet
- Also suitable for infiltration and pond systems
- Maximum flow rate of 5.5 l/sec. with connections DN 100 (4") and 16 l/sec. with DN 150 (6")



Connection dimensions

① Inlet	273–723 mm (10.7–28.5")
② Outlet	544–944 mm (21.4–37.2")
③ Emergency overflow	273–723 mm (10.7–28.5")

All dimensions from middle of connection to ground level

Q Webcode G2205

Universal filter 3 external

Suitable for pedestrian loading

Order no. 340020

Universal filter 3 external

Suitable for vehicle loading

Order no. 340021

Infiltration connecting piece DN 400 (16")

To produce greater installation depths, effective length: 500 mm (19.7"), can be shortened to 250 mm (9.8")

Order no. 330341

Replacement filter basket

Filter insert with practical lift-out device

Order no. 340524



Universal industrial filter 3 external

- For maximum flow rate of up to 29.5 l/sec.
- Continuously variable installation depth of 703–1270 mm (26.7–50.0") using the telescopic dome shaft
- Maximum flow rate of 16 l/sec. with connections DN 150 (6") and 29.5 l/sec. with DN 200 (8")
- Only 229 mm (9") height offset between the inlet and the outlet

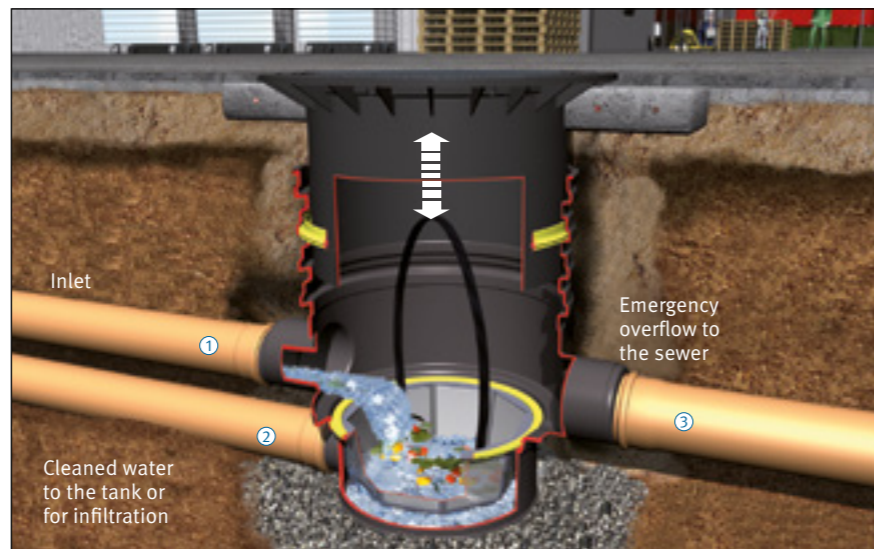

Q Webcode G2202

Universal industrial filter 3 external

Suitable for pedestrian loading

Order no. 340050

Universal industrial filter 3 external

Suitable for vehicle loading

Order no. 340051

Infiltration filter strainer DN 600 (24")

Made entirely from stainless steel, mesh width 0.75 mm (0.03")

Order no. 340523

Connection dimensions

① Inlet	DN 150 (6") / 200 (8")	395–962 mm (15.6–37.9")
② Outlet	DN 150 (6")	624–1191 mm (24.6–46.9")
③ Emergency overflow	DN 150 (6") / 200 (8")	395–962 mm (15.6–37.9")

All dimensions from middle of connection to ground level

Infiltration filter shaft / settling filter shaft



Infiltration filter shaft

- 3-stage cleaning process
 - ① Coarse filter insert
 - ② Fine filter basket 0.35 mm (0.01") mesh width
 - ③ Sedimentation zone
- Retains contaminants which may affect infiltration performance
- Ideal as a courtyard inlet structure or a trough-trench overflow element
- Suitable for vehicle loading with cast iron cover 3.5 t
- Continuously variable installation depth of 570 – 1050 mm (22.4" – 41.3") using telescopic dome shaft Ø 400 mm
- Maximum flow rate of 5.5 l/sec. with DN 100 (4") and 16 l/sec. with DN 150 (6")
- DN 100 (4") and DN 150 (6") connections

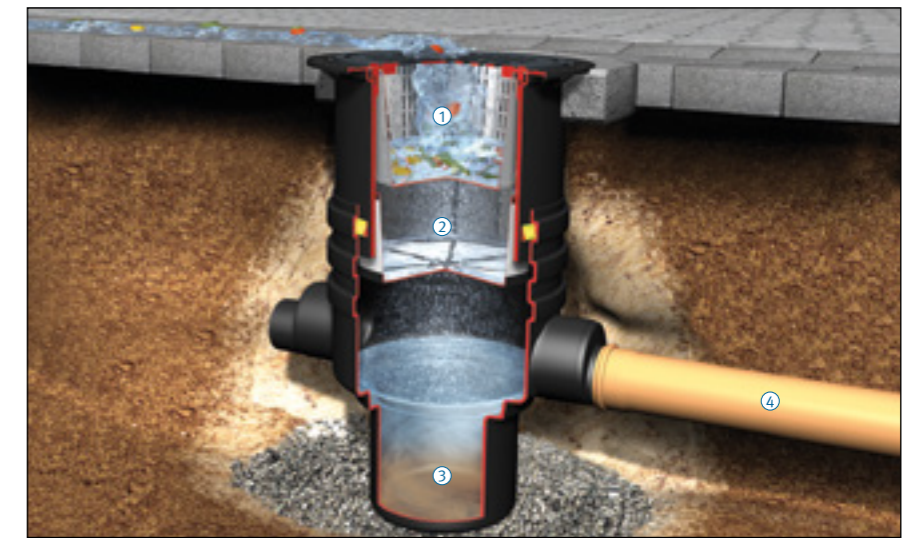

Q Webcode G4401

Infiltration filter shaft

Suitable for vehicle loading

Order no. 340025

Infiltration connecting piece DN 400 (16")

To produce greater installation depths, effective length: 500 mm (19.7"), can be shortened to 250 mm (9.8")

Order no. 330341

Connection dimensions

④ Outlet	245–725 mm (9.6–28.5")
----------	------------------------

All dimensions from middle of connection to ground level

Settling filter shaft

- 3-stage cleaning process
 - ① Fine filter basket 0.35 mm (0.01") mesh width
 - ② Sedimentation zone
 - ③ Immersion pipe as separator
- Continuously variable installation depth of 900– 1600 mm (2' 11.4"–5' 3") using telescopic dome shaft Ø 600 mm
- Pedestrian loading with plastic cover, or suitable for vehicle loading with cast iron cover 3.5 t
- Lockable childproof cover
- Sealed to top edge of ground
- Maximum flow rate of 16 l/sec. with DN 150 (6")
- DN 150 (6") connections

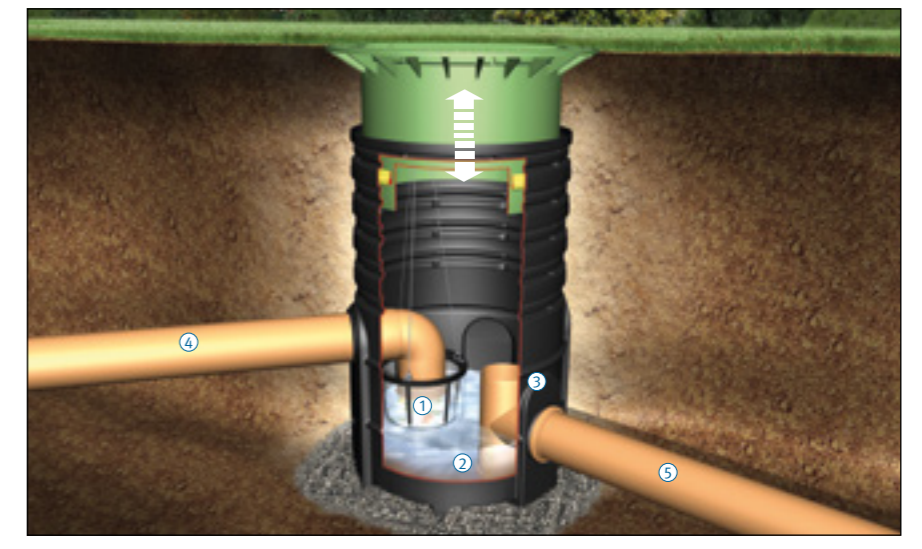

Q Webcode G4402

Settling filter shaft

pedestrian loading

Order no. 340026

Settling filter shaft

Suitable for vehicle loading

Order no. 340027

Infiltration connecting piece 1000 DN 600 (24")

With DN 200 (8") contact surface, incl. profile seal, length 1000 mm (3' 3.3"), 750 mm (2' 5.5"), 500 mm (1' 7.7")

Order no. 371015

Connection dimensions

④ Inlet	380–1080 mm (15–42.5")
⑤ Outlet	630–1330 mm (24.8–52.4")

All dimensions from middle of connection to ground level

KLsepa.compact

Light fluid separator



Separator systems for light fluid liquids class I + II

Separators are needed wherever water is contaminated with oils and other light liquids. Separator systems are classified according to NS (nominal size). When you submit an enquiry for a separator system, we calculate the NS you require based on the EN 858 part 2. Operators of the following facilities must ensure that a suitable, functioning separator is installed:

Car washes, workshops, fuel stations, vehicle fleets, hazardous goods stores

Coalescence separator and fuel separator

The KLsepa.compact+ separator systems are coalescence separators of class I. They feature an additional coalescence unit that enables a much higher degree of separation. The KLsepa.compact separator systems are fuel separators of class II. A fuel separator achieves a degree of separation of less than 100 mg residual oil per litre of water. With a coalescence unit, this can be reduced to less than 5 mg/l.

Tank cover
Optional sludge collector
Expansion possible through optional sludge collector

Coalescence unit included with KLsepa.compact+ system

Warning sensors

INTEGRATED SAMPLING CONNECTION POINT

Illustration shows Saphir NS 3 KLsepa.compact+ with coalescence unit, integrated sampling connection point

integrated sampling connecting point

Optional: different warning systems available

Tank covers
on request



EN 858-1

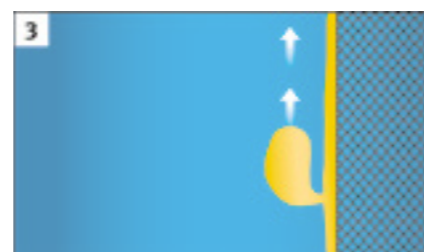
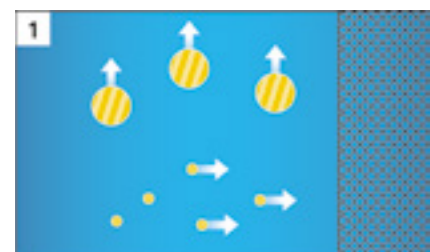

In addition to easily separate drops of oil, a light fluid separator also contains very fine oil droplets whose density is not sufficiently different from water for them to rise to the surface in the available time. These droplets therefore remain in the outflowing water.

To separate out these smaller droplets, a coalition material is fitted before the discharge to which the droplets stick and form an oil film.

As more oil flows in, the film becomes thicker until it can no longer adhere to the material. Individual drops break off the film, which are large enough to rise to the surface through difference in density and be separated out.

Dimensions Saphir

NS [l/s]	DN [mm]	Length [mm]	Width [mm]	Height [mm]	Weight [kg]
3 (0.79 US gal./s)	150 (6")	1155 (3' 9.5")	1155 (3' 9.5")	1790-1990 (5' 11"-6' 6.4")	80 (176 lbs.)
3 (0.79 US gal./s)	150 (6")	1155 (3' 9.5")	1155 (3' 9.5")	2110-2310 (6' 11"-7' 7")	110 (243 lbs.)
3 (0.79 US gal./s)	150 (6")	1155 (3' 9.5")	1155 (3' 9.5")	2110-2310 (6' 11"-7' 7")	110 (243 lbs.)
6 (1.60 US gal./s)	150 (6")	1155 (3' 9.5")	1155 (3' 9.5")	2110-2310 (6' 11"-7' 7")	110 (243 lbs.)

Effectiveness according to EN 858 tested by TÜV Rheinland.

Dimensions Diamant

NS [l/s]	DN [mm]	Length [mm]	Width [mm]	Height [mm]	Weight [kg]
6 (1.60 US gal./s)	150 (6")	2450 (8')	1150 (3' 9")	1765-2055 (5' 9.5"-6' 9")	165 (364 lbs.)
10 (2.64 US gal./s)	150 (6")	2450 (8')	1150 (3' 9")	1765-2055 (5' 9.5"-6' 9")	165 (364 lbs.)
10 (2.64 US gal./s)	200 (8")	2450 (8')	1400 (4' 7")	2020-2310 (6' 7.5"-7' 7")	250 (551 lbs.)
15 (3.96 US gal./s)	200 (8")	2450 (8')	1400 (4' 7")	2020-2310 (6' 7.5"-7' 7")	250 (551 lbs.)

Effectiveness according to EN 858 tested by TÜV Rheinland.

Tank volume

Oil [l]	Sludge [l]	Total [l]
300 (79 US gal.)	300 (79 US gal.)	770 (203 US gal.)
500 (132 US gal.)	400 (105 US gal.)	1,100 (290 US gal.)
300 (79 US gal.)	600 (158 US gal.)	1,080 (288 US gal.)
300 (79 US gal.)	600 (158 US gal.)	1,080 (288 US gal.)

Tank volume

Oil [l]	Sludge [l]	Total [l]
500 (132 US gal.)	1,300 (343 US gal.)	2,210 (584 US gal.)
500 (132 US gal.)	1,300 (343 US gal.)	2,210 (584 US gal.)
660 (174 US gal.)	2,000 (528 US gal.)	3,330 (880 US gal.)
660 (174 US gal.)	2,000 (528 US gal.)	3,330 (880 US gal.)



Detention

Detention systems, i.e. rainwater detention, play an important role in the reduction of hydraulic peaks and thus help relieve strain on the public sewer network, particularly in new construction areas. Detention systems usually consist of a volume which is used for the temporary storage of rainwater in the event of heavy rainfall, and a throttling device to limit the draining runoff water. The rainwater is cleaned using a filter before it enters the detention volume in order to avoid compromising the function of the throttling device. The throttled flow of rainfall is fed into the sewer and the excess amount is retained in the deten-

tion cistern. This amount accumulates in the detention cistern and is also drained off with the throttled runoff water after the rainfall event. The detention volume is thus discharged and remains available once more as a temporary storage tank for the next rainfall event.

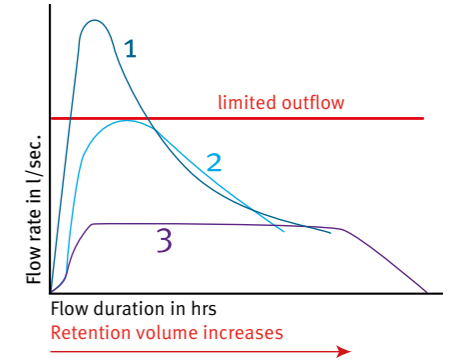

1. Outflow rate without throttle
2. Outflow rate with static throttle
3. Outflow rate with dynamic throttle

Retention

The GRAF retention cistern is a combination of rainwater retention and rainwater harvesting. The detention can be larger if required. In this case, part of the rainwater can also be used in addition to the required detention volume. For example, rainwater can be used for the following applications:

- Watering gardens
- Flushing toilets
- Washing machines
- Cleaning

The use of rainwater means that up to 50% of drinking water can be saved, and up to 85% for commercial properties.

The retention cistern is designed such that the rainwater first fills the usage volume. When the useful volume is full, the throttled outflow is activated and the detention volume also becomes available for temporary storage. The detention mechanism with throttled outflow in turn corresponds to a conventional retention system. Following the rainfall event, the position of the outflow prevents the detention cistern from being completely emptied, while the usage volume remains in the tank!

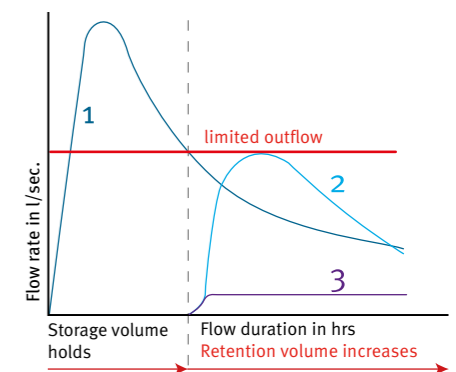

1. Outflow rate without throttle
2. Outflow rate with static throttle
3. Outflow rate with dynamic throttle

	Detention	Retention
Rainwater detention	✓	✓
Rainwater harvesting		✓

Carat S underground tank Detention cistern

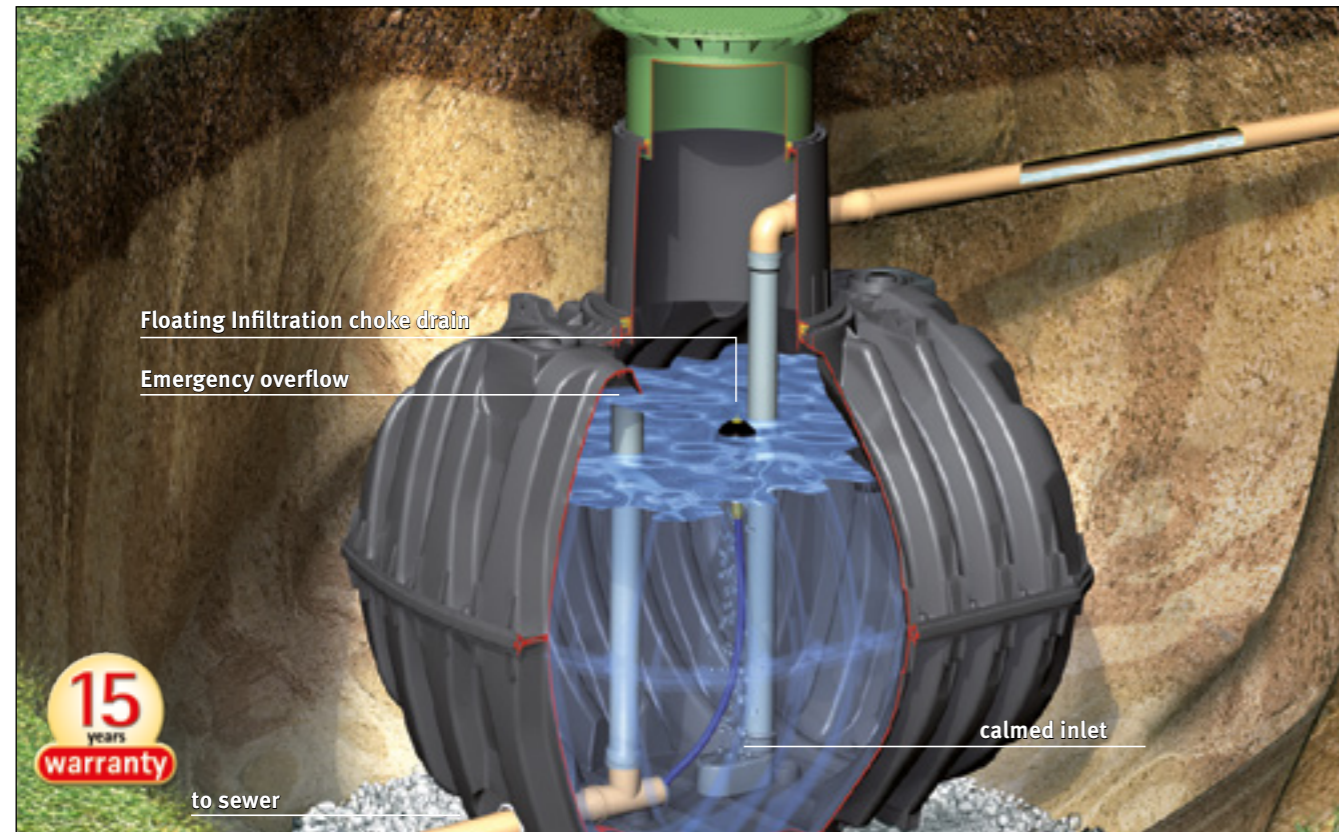

Figure shows Carat S detention cistern, tank cover on page 51

Q Webcode G4301

Rainwater harvesting solutions

For more information about our Carat S Rainwater tank please refer to our brochure "Rainwater harvesting solutions"



Carat S choke drain package detention / retention
0.05 – 2.0 l (0.01 – 0.5 US gal.) / sec,
DN 100 (4") connection, 3 m (9' 10.1") hose
Order no. 369020

HIGHER OUTFLOWS ON REQUEST

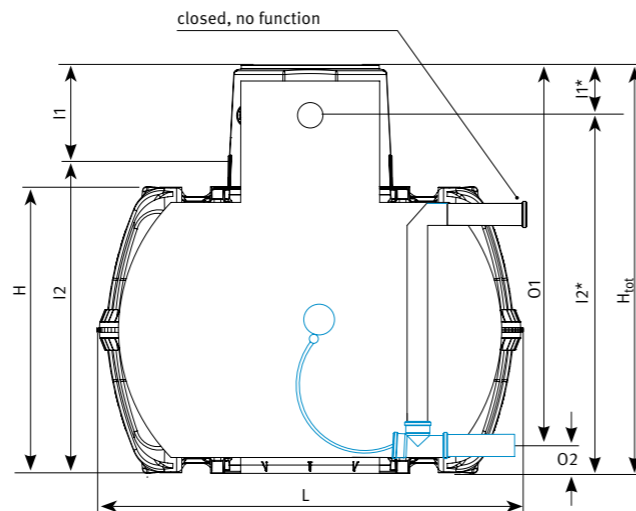

Carat S underground tank detention cistern

Capacity	Width W	Length L	Height H _{tot}	Height H	Inlet I1	Inlet I2	Inlet I1*	Inlet I2*	Outlet O1	Outlet O2
2,700 l (700 US gal.)	1565 mm (5' 1.6")	2080 mm (6' 9.9")	1690 mm (5' 6.5")	1400 mm (4' 7.1")	520 mm (20.5")	1490 mm (4' 10.7")	245 mm (9.6")	1955 mm (6' 4.9")	1530 mm (5' 0.2")	160 mm (6.3")
3,750 l (1,000 US gal.)	1755 mm (5' 9.0")	2280 mm (7' 5.8")	2200 mm (7' 2.6")	1590 mm (5' 2.6")	520 mm (20.5")	1680 mm (5' 6.2")	245 mm (9.6")	2185 mm (7' 2.0")	2040 mm (6' 8.3")	160 mm (6.3")
4,800 l (1,250 US gal.)	1985 mm (6' 6.2")	2280 mm (7' 5.7")	2430 mm (7' 11.7")	1820 mm (5' 11.7")	520 mm (20.5")	1910 mm (6' 3.2")	245 mm (9.6")	2465 mm (8' 1.0")	2270 mm (7' 5.4")	160 mm (6.3")
6,500 l (1,700 US gal.)	2190 mm (7' 2.2")	2390 mm (7' 10.0")	2710 mm (8' 10.7")	2100 mm (6' 10.7")	520 mm (20.5")	2190 mm (7' 2.2")	245 mm (9.6")	1920 mm (6' 3.6")	2550 mm (8' 4.4")	160 mm (6.3")

Please refer to the installation instructions for groundwater installation and loading capacity.

Carat S underground tank Retention cistern

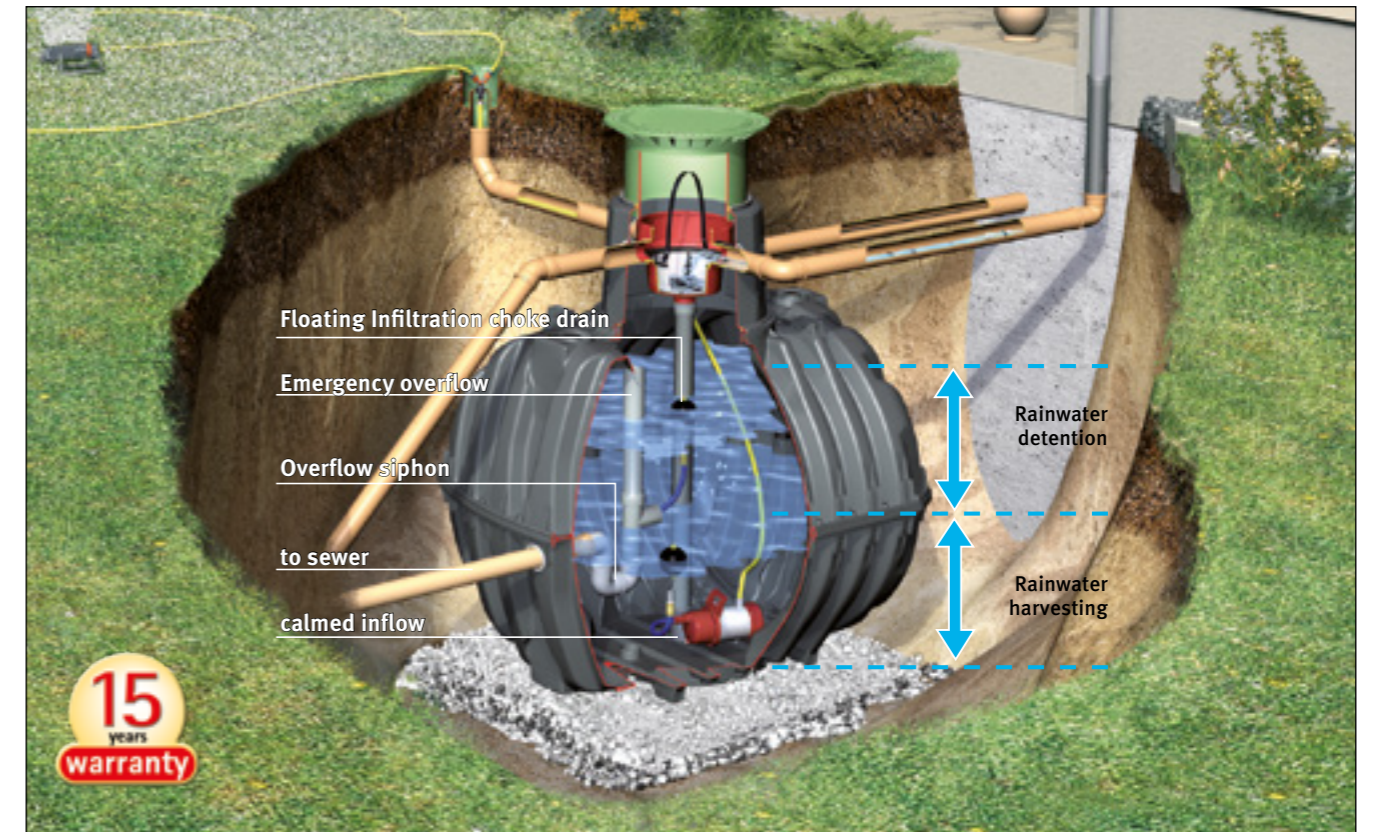

Figure shows Carat S retention cistern, tank cover on page 51

Q Webcode G4302

Rainwater harvesting solutions

For more information about our Carat S Rainwater tank please refer to our brochure "Rainwater harvesting solutions"



Carat S choke drain package detention / retention
0.05 – 2.0 l (0.01 – 0.5 US gal.) / sec,
DN 100 (4") connection, 3 m (9' 10.1") hose
Order no. 369020

HIGHER OUTFLOWS ON REQUEST

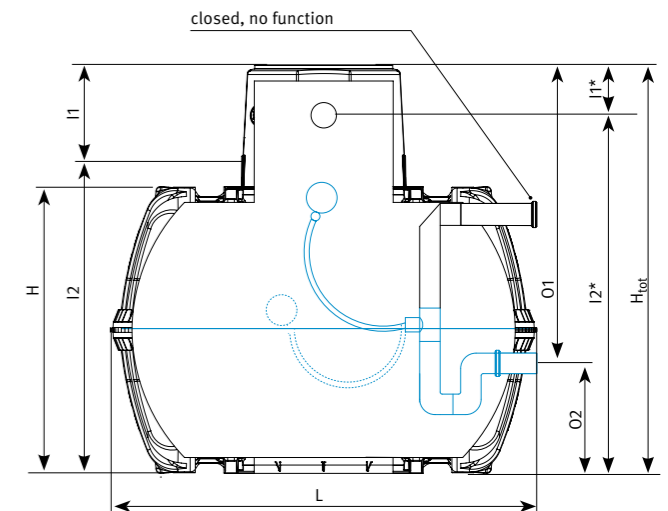

Carat S underground tank retention cistern

Capacity	Detention volume	Usage volume	Width W	Length L	Height H _{tot}	Height H	Inlet I1	Inlet I2	Inlet I1*	Inlet I2*	Outlet O1	Outlet O2
3,750 l (1,000 US gal.)	1,500 l (400 US gal.)	2,250 l (600 US gal.)	1755 mm (5' 9.0")	2280 mm (7' 5.8")	2200 mm (7' 2.6")	1590 mm (5' 2.6")	520 mm (20.5")	1680 mm (5' 6.2")	245 mm (9.6")	1955 mm (6' 4.9")	2040 mm (6' 8.3")	160 mm (6.3")
4,800 l (1,250 US gal.)	2,000 l (520 US gal.)	2,800 l (730 US gal.)	1985 mm (6' 6.2")	2280 mm (7' 5.7")	2430 mm (7' 11.7")	1820 mm (5' 11.7")	520 mm (20.5")	1910 mm (6' 3.2")	245 mm (9.6")	2185 mm (7' 2.0")	2270 mm (7' 5.4")	160 mm (6.3")
6,500 l (1,700 US gal.)	3,000 l (800 US gal.)	3,500 l (900 US gal.)	2190 mm (7' 2.2")	2390 mm (7' 10.0")	2710 mm (8' 10.7")	2100 mm (6' 10.7")	520 mm (20.5")	2190 mm (7' 2.2")	245 mm (9.6")	2465 mm (8' 1.0")	2550 mm (8' 4.4")	160 mm (6.3")

Please refer to the installation instructions for groundwater installation and loading capacity.

Platin flat tank Detention cistern

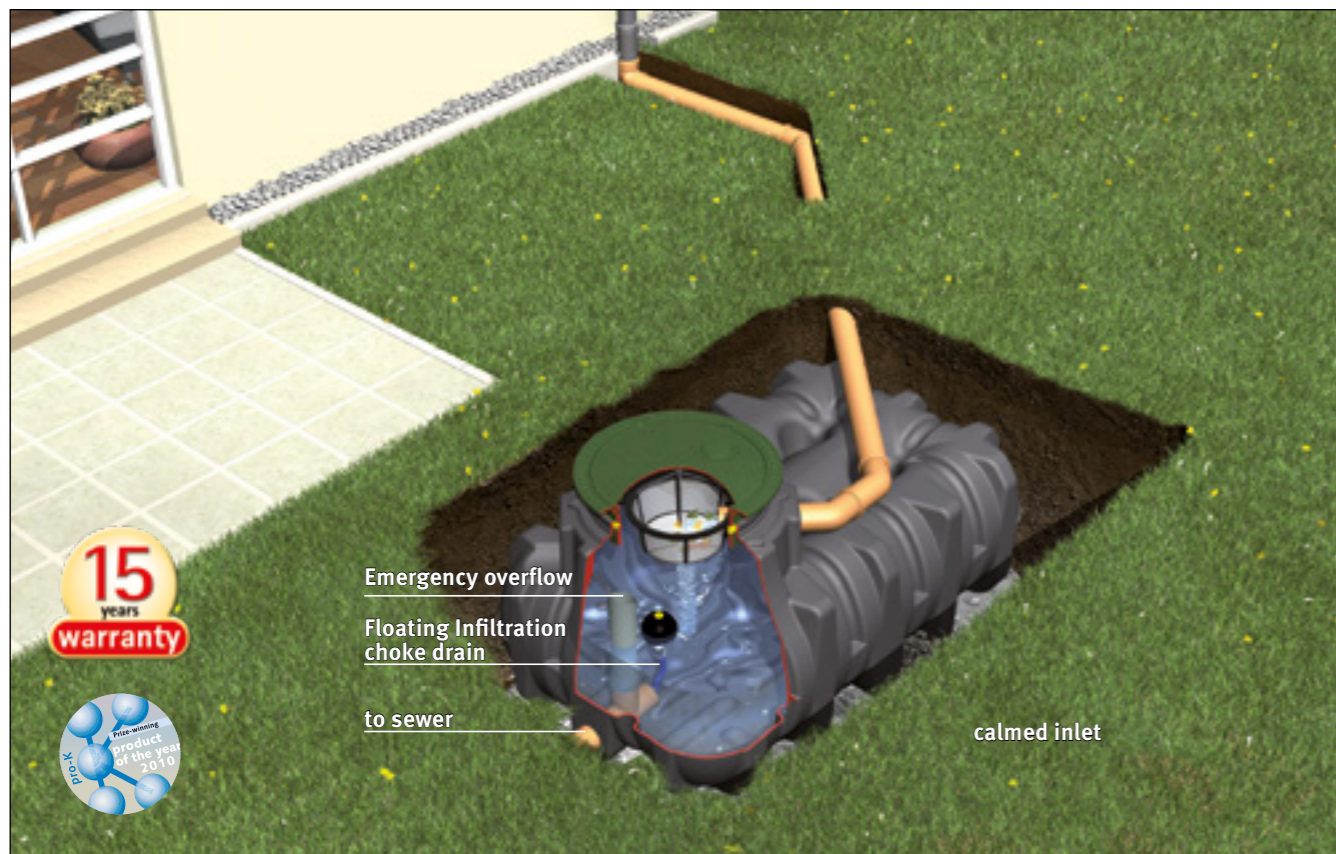

Figure shows Platin detention cistern, tank cover on page 51

Webcode G4303

Volume	Detention volume	Order no.
1,500 l (400 US gal.)	1,500 l (400 US gal.)	390300
3,000 l (800 US gal.)	3,000 l (800 US gal.)	390301
5,000 l (1,350 US gal.)	5,000 l (1,350 US gal.)	390302
7,500 l (2,000 US gal.)	7,500 l (2,000 US gal.)	390305
10,000 l ¹⁾ (2,650 US gal.)	10,000 l ¹⁾ (2,650 US gal.)	390304

Scope of supply: Platin tank, floating choke drain and hose.
Cover has to be ordered separately, page 51

Rainwater harvesting solutions

For more information about our Platin flat tank please refer to our brochure "Rainwater harvesting solutions"

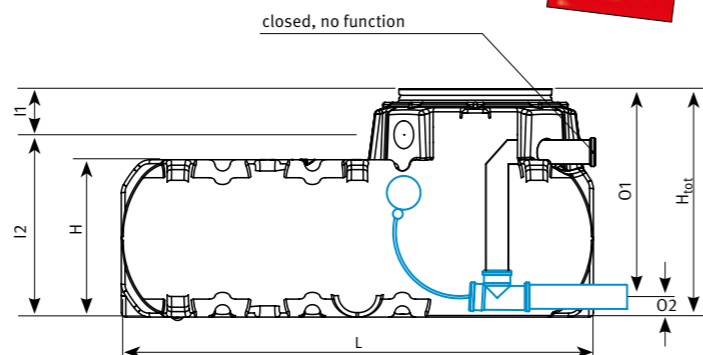

Platin flat tank detention cistern

Volume	Width W	Length L	Height H _{tot}	Height H	Inlet I1	Inlet I2	Outlet O1	Outlet O2
1,500 l (400 US gal.)	1250 mm (4' 1.1")	2100 mm (6' 10.7")	1015 mm (3' 3.9")	700 mm (27.6")	185 mm (7.3")	830 mm (32.7")	925 mm (36.4")	90 mm (3.5")
3,000 l (800 US gal.)	2100 mm (6' 10.7")	2450 mm (8' 0.5")	1050 mm (3' 5.3")	735 mm (28.9")	185 mm (7.3")	865 mm (34.1")	960 mm (37.8")	90 mm (3.5")
5,000 l (1,350 US gal.)	2300 mm (7' 6.5")	2890 mm (9' 5.8")	1265 mm (4' 1.8")	950 mm (37")	185 mm (7.3")	1080 mm (3' 6.5")	1175 mm (3' 10.3")	90 mm (3.5")
7,500 l (2,000 US gal.)	2250 mm (7' 4.6")	3600 mm (11' 9.7")	1565 mm (5' 1.6")	1250 mm (4' 1.1")	185 mm (7.3")	1380 mm (4' 6.3")	1475 mm (4' 10.1")	90 mm (3.5")

Please refer to the installation instructions for groundwater installation and loading capacity.

Platin flat tank Retention cistern



THE VOLUME DISTRIBUTION (DETENTION VOLUME/USAGE VOLUME) CAN BE INDIVIDUALLY MANUFACTURED ACCORDING TO YOUR SPECIFICATIONS.

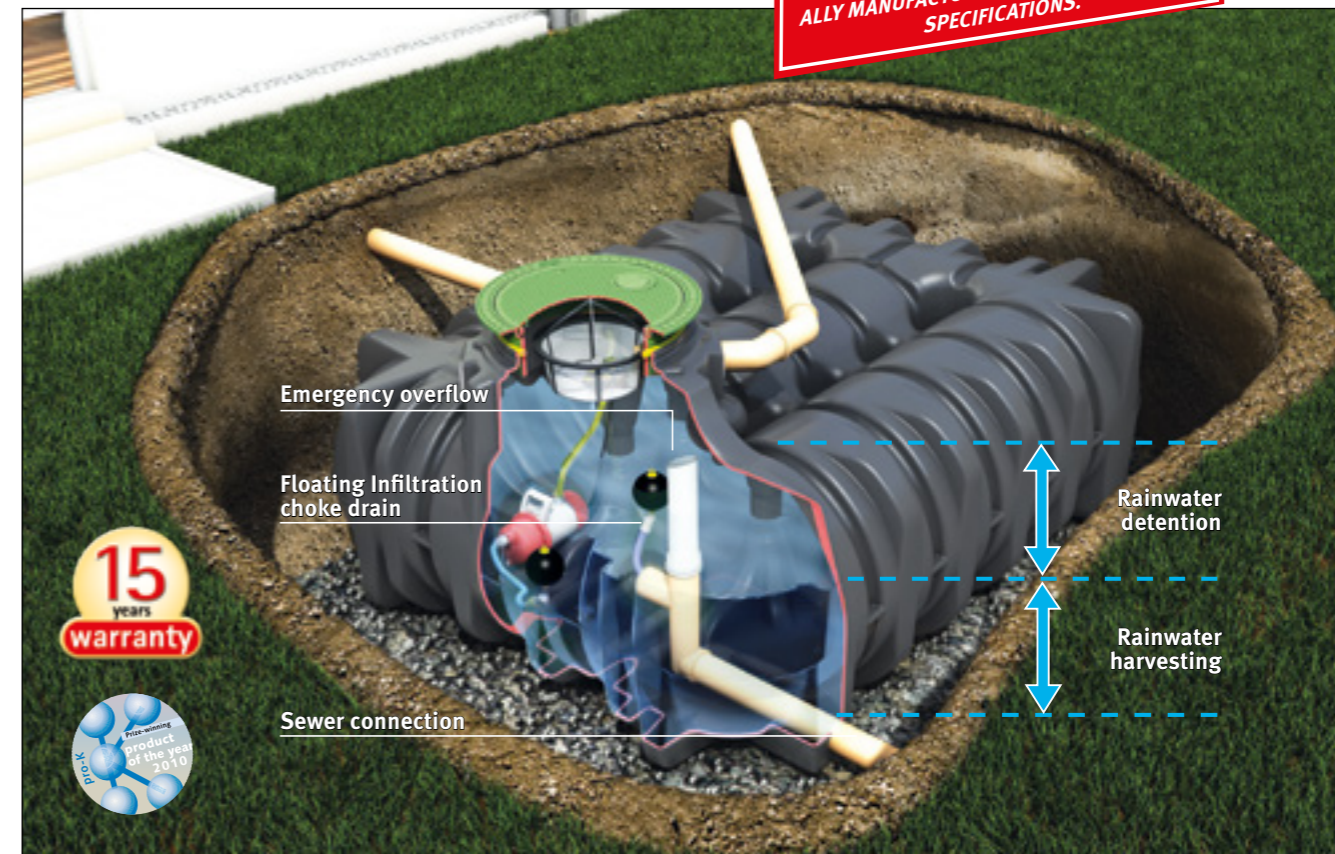

Figure shows Platin retention cistern, tank cover on page 51

Webcode G4304

Volume	Detention volume	Usage volume	Order no.
3,000 l (800 US gal.)	3,000 l (800 US gal.)	2,000 l (520 US gal.)	390312
5,000 l (1,350 US gal.)	4,500 l (1,200 US gal.)	3,000 l (800 US gal.)	390315
7,500 l (2,000 US gal.)	6,000 l (1,600 US gal.)	4,000 l (1,200 US gal.)	390324
10,000 l ¹⁾ (2,650 US gal.)	6,000 l (1,600 US gal.)	4,000 l (1,200 US gal.)	390321

Scope of supply: Platin tank, floating choke drain and hose.
Cover has to be ordered separately, page 51

Rainwater harvesting solutions

For more information about our Platin flat tank please refer to our brochure "Rainwater harvesting solutions"

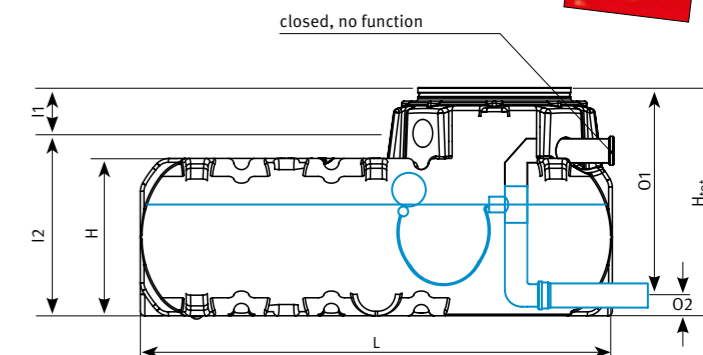
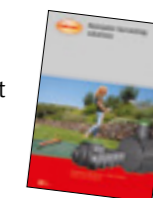

Platin flat tank retention cistern

For combined rainwater detention and rainwater harvesting, including retention accessories

Volume	Width W	Length L	Height H _{tot}	Height H	Inlet I1	Inlet I2	Outlet O1	Outlet O2
3,000 l (800 US gal.)	2100 mm (6' 10.7")	2450 mm (8' 0.5")	1050 mm (3' 5.3")	735 mm (28.9")	185 mm (7.3")	865 mm (34.1")	960 mm (37.8")	90 mm (3.5")
5,000 l (1,350 US gal.)	2300 mm (7' 6.5")	2890 mm (9' 5.8")	1265 mm (4' 1.8")	950 mm (37")	185 mm (7.3")	1080 mm (3' 6.5")	1175 mm (3' 10.3")	90 mm (3.5")
7,500 l (2,000 US gal.)	2250 mm (7' 4.6")	3600 mm (11' 9.7")	1565 mm (5' 1.6")	1250 mm (4' 1.1")	185 mm (7.3")	1380 mm (4' 6.3")	1475 mm (4' 10.1")	90 mm (3.5")

Further sizes upon request!

Please refer to the installation instructions for groundwater installation and loading capacity.

¹⁾ Set consisting of two Platin flat tanks

Carat XL underground tank detention / retention cistern



Carat XL underground tank Suitable for vehicle / lorry 12 t

- Suitable for HGV loading up to 12 t
- Can be mounted in groundwater
- Lower weight than concrete and steel
- Various connection surfaces DN 100 (4") / 150 (6")
- Investment security thanks to a 15 year warranty
- Can be used as detention or retention cistern



THE VOLUME DISTRIBUTION (DETENTION VOLUME/USAGE VOLUME) CAN BE INDIVIDUALLY MANUFACTURED ACCORDING TO YOUR SPECIFICATIONS.



Figure shows 10,000 l (2,640 US gal.) tank with cast iron telescopic dome shaft suitable for vehicle loading

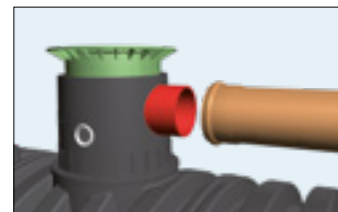

Larger connection fittings upon request

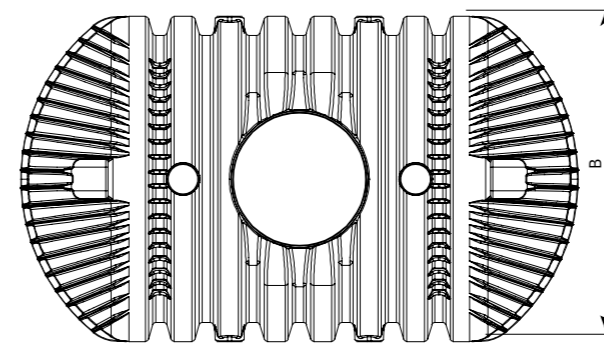
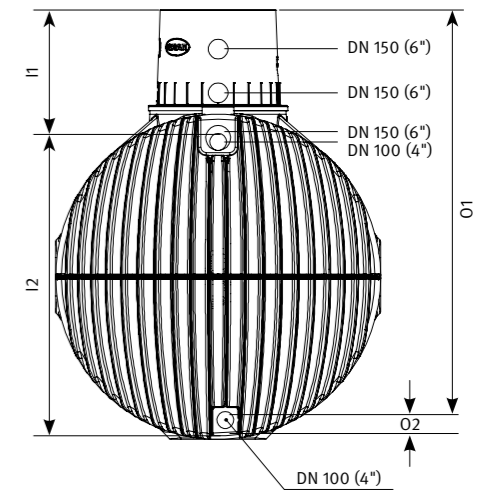
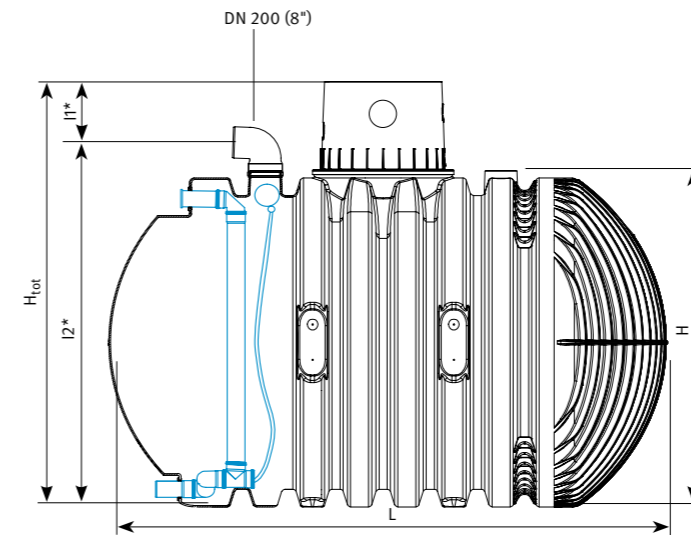

Figure shows tank without cover. The total installation height results from the total tank height (H_{tot}) plus the telescopic dome shaft (page 51).

Carat XL underground tank detention cistern

Total volume / Detention volume	Weight	Order no.
8,500 l (2,242 US gal.)	380 kg (838 lbs)	370504
10,000 l (2,640 US gal.)	456 kg (1,005 lbs)	370505

[Webcode G4307](#)

Carat XL underground tank retention cistern

Total volume	Detention volume	Usage volume	Order no.
8,500 l (2,242 US gal.)	3,500 l (923 US gal.)	5,000 l (1,320 US gal.)	370523
10,000 l (2,640 US gal.)	4,000 l (1,055 US gal.)	6,000 l (1,583 US gal.)	370525

[Webcode G4308](#)

Scope of supply: Carat XL underground rainwater tank with Maxi tank dome, choke drain and hose

Carat XL underground tank detention and retention cistern

Volume	Width W	Length L	Height H_{tot}	Height H	Inlet I1	Inlet I2	Inlet I1*	Inlet I2*	Outlet O1	Outlet O2
8,500 l (2,250 US gal.)	2040 mm (6' 8.3")	3500 mm (11' 5.8")	2695 mm (8' 10.1")	2085 mm (6' 10.1")	805 mm (31.7")	1890 mm (6' 2.4")	435 mm (17.1")	2625 mm (8' 7.4")	2585 mm (8' 5.8")	110 mm (4.3")
10,000 l (2,650 US gal.)	2240 mm (7' 4.2")	3520 mm (11' 6.6")	2895 mm (9' 6.0")	2285 mm (7' 6.0")	805 mm (31.7")	2090 mm (6' 10.3")	435 mm (17.1")	2625 mm (8' 7.4")	2785 mm (9' 1.7")	110 mm (4.3")

Technical data

max. axle load:	8 t
max. total weight:	12 t
Earth covering with loading capacity:	800 – 1500 mm (2' 7.5" – 4' 11")
Groundwater stability:	up to the middle of the tank
Earth covering with groundwater installation:	800 – 1500 mm (2' 7.5" – 4' 11")
Connection options:	DN 100 (4") / DN 150 (6"), DN 200 (8") on top
Tank dome inner Ø:	650 mm (25.6")

Carat XXL underground tank

up to 122,000 litres (32,230 US gal.)



Carat XXL underground tank Suitable for vehicle/lorry 40 t

- Suitable for HGV loading up to 40 t
- Can be mounted in groundwater
- Lower weight than concrete and steel
- Various connection surfaces
DN 100 (4")/150 (6")/200 (8")
- Available with DN 300 (12") connection as an option
- Available with a second tank dome as an option
- 122,000 litres (32,230 US gal.)
Volume possible
- Investment security thanks to a
15 year warranty

Webcode G1104

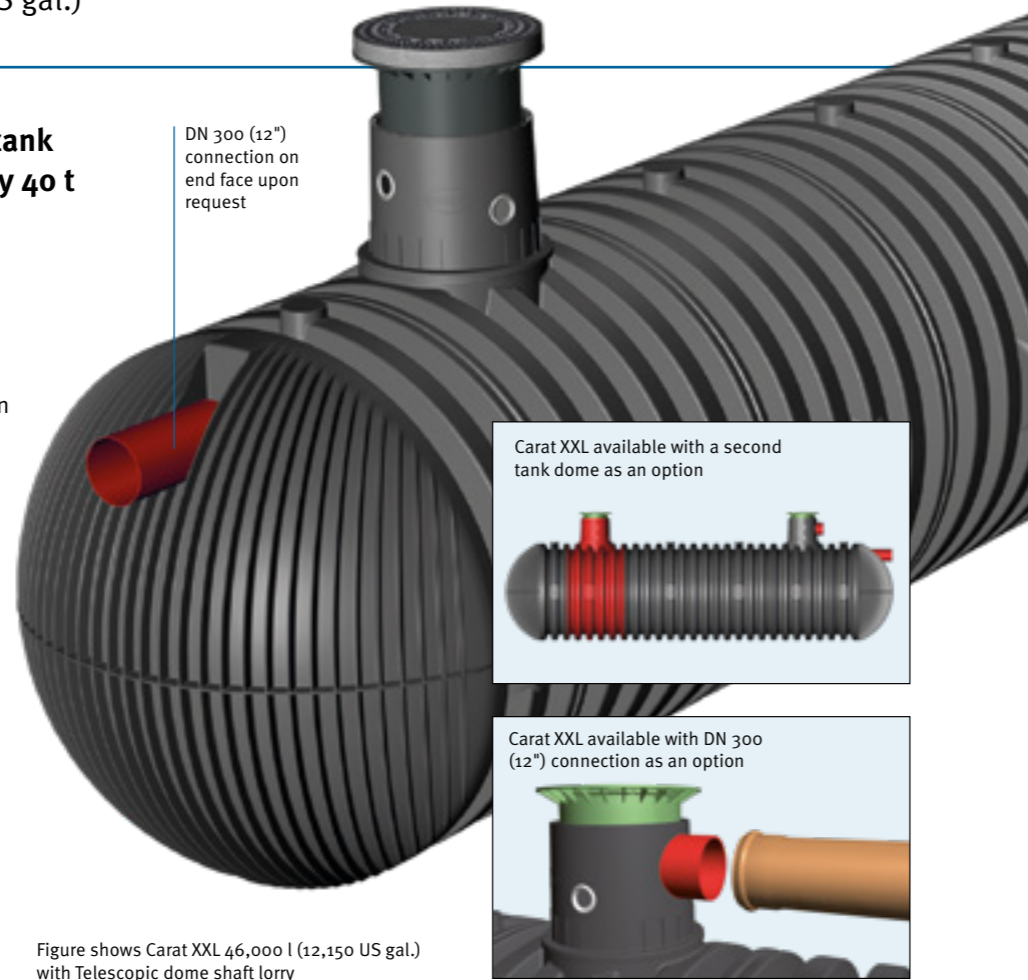
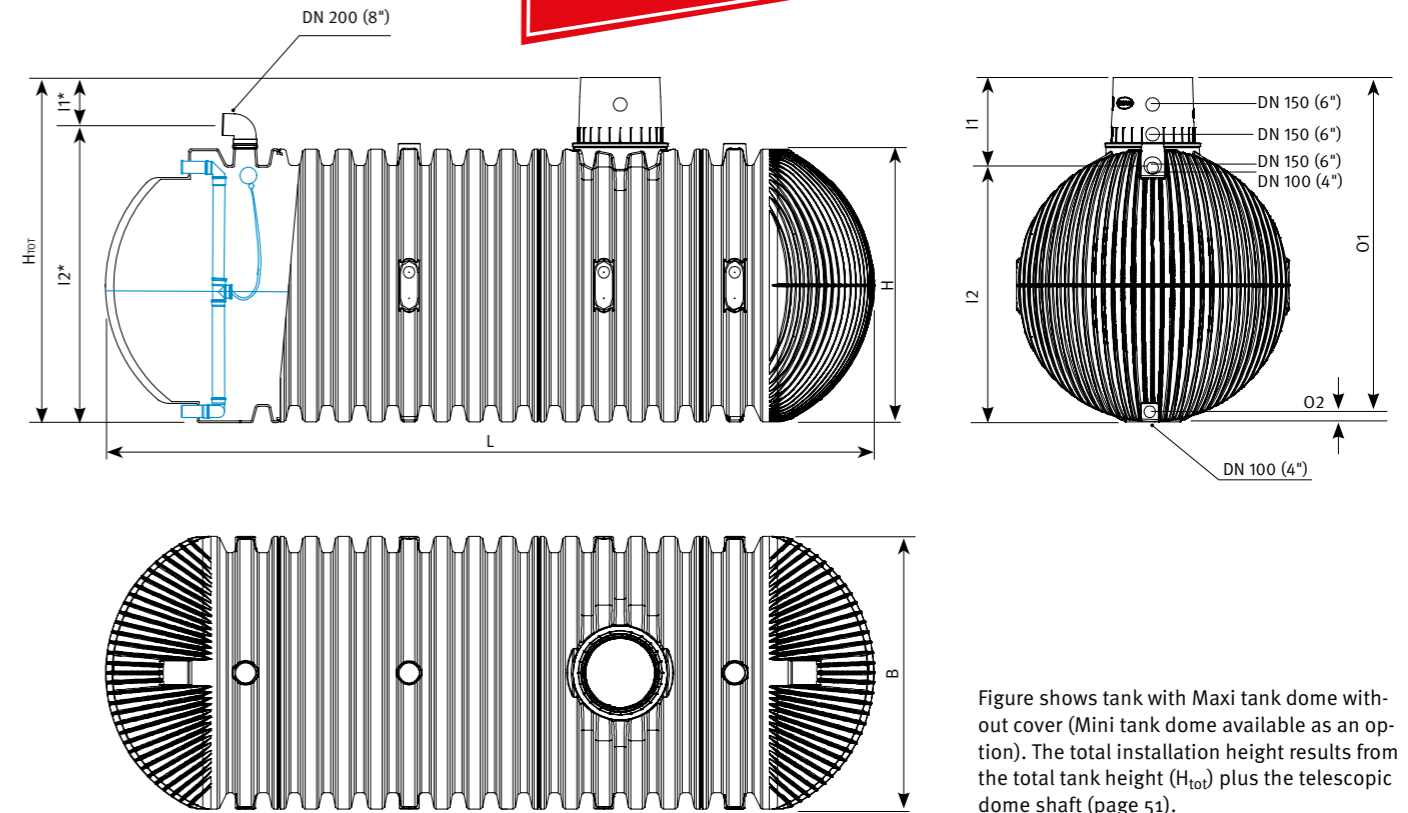

Figure shows Carat XXL 46,000 l (12,150 US gal.) with Telescopic dome shaft lorry

CARAT XXL AVAILABLE AS DETENTION AND RETENTION CISTERN. CAN BE INDIVIDUALLY MANUFACTURED ACCORDING TO YOUR SPECIFICATIONS.



Carat XXL underground rainwater tank

Capacity	Tank dome inner Ø	Weight	Order no. detention	Order no. retention
16,000 l (4,250 US gal.)	650 mm (25.6")	805 kg (1.770 lbs)	380500	380520
22,000* (5,800 US gal.)	650 mm (25.6")	1015 kg (2.250 lbs)	380501	380521
26,000 (6,900 US gal.)	650 mm (25.6")	1150 kg (2.550 lbs)	380502	380522
32,000* (8,450 US gal.)	650 mm (25.6")	1360 kg (3.000 lbs)	380503	380523
36,000 (9,500 US gal.)	650 mm (25.6")	1495 kg (3.300 lbs)	380504	380524
42,000* (11,100 US gal.)	650 mm (25.6")	1705 kg (3.750 lbs)	380505	380525
46,000 (12,150 US gal.)	650 mm (25.6")	1840 kg (4.050 lbs)	380506	380526
52,000* (13,750 US gal.)	650 mm (25.6")	2050 kg (4.500 lbs)	380507	380527
56,000 (14,800 US gal.)	650 mm (25.6")	2185 kg (4.800 lbs)	380508	380528
62,000* (16,400 US gal.)	650 mm (25.6")	2395 kg (5.280 lbs)	380509	380529
66,000 (17,450 US gal.)	650 mm (25.6")	2530 kg (5.600 lbs)	380510	380530
72,000* (19,000 US gal.)	650 mm (25.6")	2740 kg (6.050 lbs)	380511	380531
76,000 (20,100 US gal.)	650 mm (25.6")	2875 kg (6.350 lbs)	380512	380532

up to 122,000 litres (32,230 US gal.) upon request

*with a second tank dome

Scope of supply: Carat XL underground rainwater tank with Maxi tank dome, choke drain and hose

Technical data

max. axle load:	8 t
max. total weight:	3.5 t with cast iron cover, 40 t with telescopic dome shaft lorry
Earth covering with loading capacity:	800 – 1500 mm (2' 7.5" – 4' 11")
Groundwater stability:	up to the middle of the tank
Earth covering with groundwater installation:	800 – 1500 mm (2' 7.5" – 4' 11")
Connection options:	DN 100 (4") – DN 200 (8")

Carat XXL underground rainwater tank

Capacity	Width W	Length L	Height H_{tot}	Height H	Inlet I1	Inlet I2	Inlet I1*	Inlet I2*	Outlet O1	Outlet O2
16,000 l (4,250 US gal.)	2500 mm (8' 2.4")	4660 mm (15' 3.4")	3160 mm (10' 4.4")	2550 mm (8' 4.4")	800 mm (2' 7.5")	2360 mm (7' 9.0")	435 mm (17.1")	2725 mm (8' 11.3")	3070 mm (10' 0.8")	90 mm (3.5")
22,000 l* (5,800 US gal.)	2500 mm (8' 2.4")	6145 mm (20' 1.9")	3160 mm (10' 4.4")	2550 mm (8' 4.4")	800 mm (2' 7.5")	2360 mm (7' 9.0")	435 mm (17.1")	2725 mm (8' 11.3")	3070 mm (10' 0.8")	90 mm (3.5")
26,000 l (6,900 US gal.)	2500 mm (8' 2.4")	7045 mm (23' 1.3")	3160 mm (10' 4.4")	2550 mm (8' 4.4")	800 mm (2' 7.5")	2360 mm (7' 9.0")	435 mm (17.1")	2725 mm (8' 11.3")	3070 mm (10' 0.8")	90 mm (3.5")
32,000 l* (8,450 US gal.)	2500 mm (8' 2.4")	8530 mm (27' 11.8")	3160 mm (10' 4.4")	2550 mm (8' 4.4")	800 mm (2' 7.5")	2360 mm (7' 9.0")	435 mm (17.1")	2725 mm (8' 11.3")	3070 mm (10' 0.8")	90 mm (3.5")
36,000 l (9,500 US gal.)	2500 mm (8' 2.4")	9430 mm (30' 11.3")	3160 mm (10' 4.4")	2550 mm (8' 4.4")	800 mm (2' 7.5")	2360 mm (7' 9.0")	435 mm (17.1")	2725 mm (8' 11.3")	3070 mm (10' 0.8")	90 mm (3.5")
42,000 l* (11,100 US gal.)	2500 mm (8' 2.4")	10915 mm (35' 9.7")	3160 mm (10' 4.4")	2550 mm (8' 4.4")	800 mm (2' 7.5")	2360 mm (7' 9.0")	435 mm (17.1")	2725 mm (8' 11.3")	3070 mm (10' 0.8")	90 mm (3.5")
46,000 l (12,150 US gal.)	2500 mm (8' 2.4")	11815 mm (38' 9.1")	3160 mm (10' 4.4")	2550 mm (8' 4.4")	800 mm (2' 7.5")	2360 mm (7' 9.0")	435 mm (17.1")	2725 mm (8' 11.3")	3070 mm (10' 0.8")	90 mm (3.5")
52,000 l* (13,750 US gal.)	2500 mm (8' 2.4")	13300 mm (43' 7.6")	3160 mm (10' 4.4")	2550 mm (8' 4.4")	800 mm (2' 7.5")	2360 mm (7' 9.0")	435 mm (17.1")	2725 mm (8' 11.3")	3070 mm (10' 0.8")	90 mm (3.5")
56,000 l (14,800 US gal.)	2500 mm (8' 2.4")	14200 mm (46' 7.1")	3160 mm (10' 4.4")	2550 mm (8' 4.4")	800 mm (2' 7.5")	2360 mm (7' 9.0")	435 mm (17.1")	2725 mm (8' 11.3")	3070 mm (10' 0.8")	90 mm (3.5")
62,000 l* (16,400 US gal.)	2500 mm (8' 2.4")	15685 mm (51' 5.5")	3160 mm (10' 4.4")	2550 mm (8' 4.4")	800 mm (2' 7.5")	2360 mm (7' 9.0")	435 mm (17.1")	2725 mm (8' 11.3")	3070 mm (10' 0.8")	90 mm (3.5")
66,000 l (17,450 US gal.)	2500 mm (8' 2.4")	16585 mm (54' 4.9")	3160 mm (10' 4.4")	2550 mm (8' 4.4")	800 mm (2' 7.5")	2360 mm (7' 9.0")	435 mm (17.1")	2725 mm (8' 11.3")	3070 mm (10' 0.8")	90 mm (3.5")
72,000 l* (19,000 US gal.)	2500 mm (8' 2.4")	18070 mm (59' 3.4")	3160 mm (10' 4.4")	2550 mm (8' 4.4")	800 mm (2' 7.5")	2360 mm (7' 9.0")	435 mm (17.1")	2725 mm (8' 11.3")	3070 mm (10' 0.8")	90 mm (3.5")
76,000 l (20,100 US gal.)	2500 mm (8' 2.4")	18970 mm (62' 2.8")	3160 mm (10' 4.4")	2550 mm (8' 4.4")	800 mm (2' 7.5")	2360 mm (7' 9.0")	435 mm (17.1")	2725 mm (8' 11.3")	3070 mm (10' 0.8")	90 mm (3.5")

up to 122,000 litres (32,230 US gal.) upon request

*with a second tank dome

Herkules detention cistern

The detention cistern with unequalled value for money. Thanks to its patented design, the transport of the Herkules Infiltration tank is very easy. The two tank halves can be assembled on site, and the patented quick connection system enables easy, tool-free installation in just a few minutes. By using the interconnecting pipe sets, the system can be extended at will. Patent no. in Europe 0870877 and USA no. 587807



**1,600 LITRES
(422 US GAL.)**

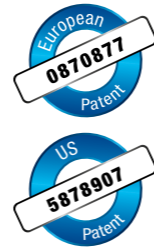

Herkules detention cistern
1,600 litres (422 US gal.)
without support pipe

Order no. 320001

[Webcode G1301](#)

Technical data

Volume	1,600 litres (422 US gal.)
Max Ø	1350 mm (53")
Height	1600 mm (63")
Material	fibre-glass reinforced PP (UV stable and 100% recyclable)
Weight	approx. 60 kg (132 lbs)
Connections	each 2 x DN 70 (2.8"), DN 100 (4") and DN 200 (8")

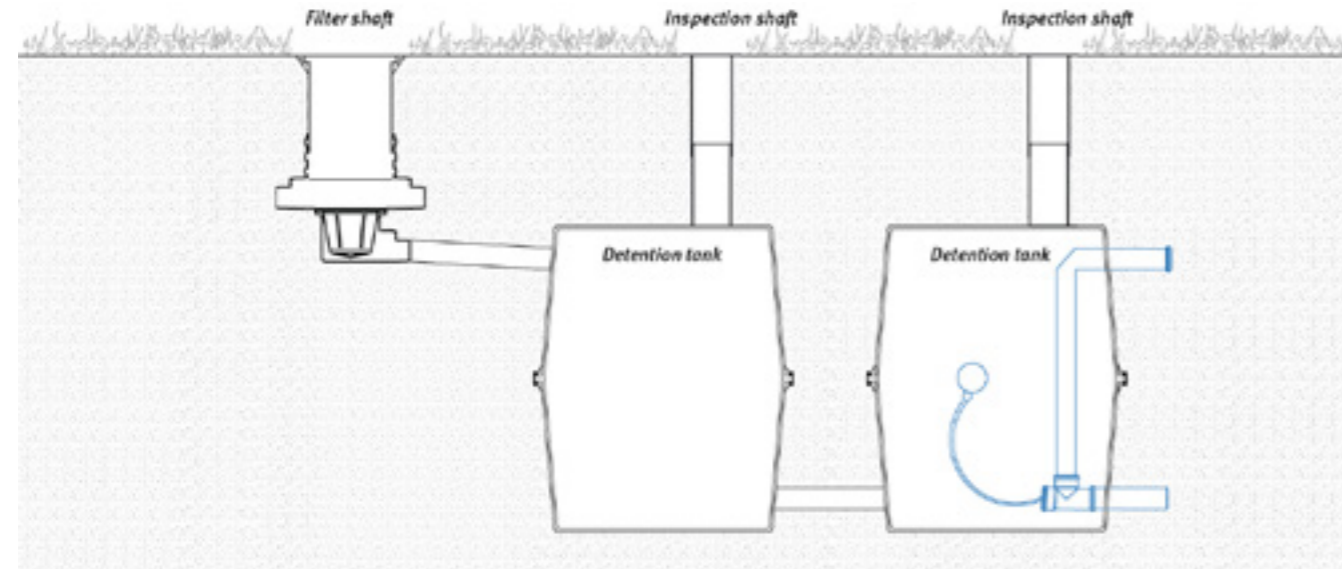

Practical advantages of Herkules

Ease of transport
Each half of the Herkules-Tank only weighs 30 kg (66 lbs). This allows ease of transport and manual installation. The tank halves fit through any doorway (80 cm (31.5") width and above).

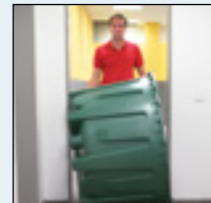

Easy to install



Several tanks can be combined



Herkules Infiltration tank



The Infiltration tank with unequalled value for money. Thanks to its patented design, the transport of the Herkules Infiltration tank is very easy. The two tank halves can be assembled on site, and the patented quick connection system enables easy, tool-free installation in just a few minutes. By using the interconnecting pipe sets, the system can be extended at will. Patent no. in Europe 0870877 and USA no. 5878907

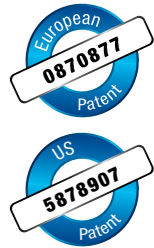

Herkules Infiltration tank
Including support pipe

Order no. 200201

[Webcode G1309](#)

Technical data

Volume	1,600 litres (422 US gal.)
Max Ø	1350 mm (53")
Height	1600 mm (63")
Material	fibre-glass reinforced PP (UV stable and 100 % recyclable)
Weight	approx. 60 kg (132 lbs)
Connections	each 2 x DN 70 (2.8"), DN 100 (4") and DN 200 (8")

Accessories for Herkules detention cistern and Herkules Infiltration tank

Cut-out tool (with pilot drill)

DN 70 (2.8")	Order no. 202002
DN 100 (4")	Order no. 202003

Interconnecting pipe set (without cut-out tool)

DN 70 (2.8")	Order no. 202029
DN 100 (4")	Order no. 202028

Tank dome

(with telescopic end 1 m (3.3') to be cut on demand)
DN 200 (8") Order no. 322026



GRAF-Tex geotextile

For one Herkules Infiltration Tank
Order no. 369015



Support pipe for Herkules tank

required for underground assembly
DN 150 (6") Order no. 322014

Material sold by the metre,
roll width 5 m (15.2')
Order no. 231002

Further application possibilities

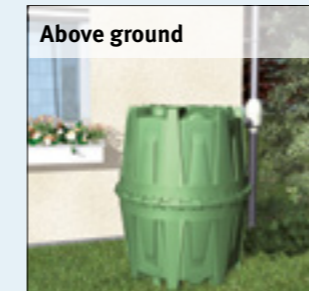

Rainwater harvesting solutions

You can find more information about our Herkules rainwater tank and other products for rainwater harvesting in our catalogue, "Rainwater harvesting solutions"

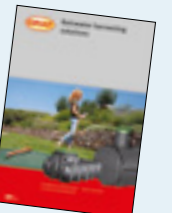



www.graf-water.com

RAINWATER HARVESTING



INFILTRATION



WASTEWATER TREATMENT SOLUTIONS



SEPARATORS



GARDEN PRODUCTS & MULTI-PURPOSE CONTAINERS



Wastewater treatment solutions

For more information about our wastewater treatment solutions, ask for our catalogue.

Prices:

A price list with our export conditions is available on request.

Warranty clause:

The warranty mentioned in this brochure only refers to the tank in question and not to the accessories. Within the warranty period we grant free replacement of the material. Further benefits are excluded. Pre-condition for warranty benefits are proper handling, assembly and installation according to the mounting guidelines.

Over and above the statutory regulation, GRAF is lengthening the warranty period for a number of underground tanks. This relates to proper handling, assembly and installation in accordance with the installation manual, as well as leakproofness, usability and static safety. The prerequisites of this are competent assembly and operation in accordance with the requirements, namely the currently valid installation and operating instructions and the prevailing standards.

N.B. Protect tanks from frost when installed aboveground! In case of groundwater installation, please contact us for further information previous to the purchase!

For all indications of measurements in this brochure we reserve a tolerance of +/- 3%. The useful volume of the tanks may be up to 10% lower than the tank capacity, according to the connecting option.

Technical modifications and further development of the different products are subject to change. Errors excepted.

For all our offers and conclusions of contract are only valid our General Terms and Conditions of Business dated 01/10/2012 which we will send to you on request.

Otto Graf GmbH
Kunststofferzeugnisse
Carl-Zeiss-Straße 2 – 6
DE-79331 Teningen

Tel.: +49 7641 589-0
Fax: +49 7641 589-50
mail@graf.info
www.graf.info

GRAF UK Ltd
Regen House
Beaumont Road
Banbury, Oxfordshire
UK-OX16 1RH

Tel.: +44 1608 661-500
Fax: +44 01295 211333
info@grafuk.co.uk
www.graf-water.com

© Otto Graf GmbH/Item no. 960288/EN

Photo copyright: Fotolia.com:
© Alexandr Ozerov (page 3)
© ps_42 (page 6)
© JWMD (page 28)
© benjaminlotte (page 49)